



# Quick Installation Guide

## Grid-Tied PV Inverter

SMT Series

(GW50K-SMT-US | GW60K-SMT-US )

V1.1-2022-07-05

## 01 IMPORTANT SAFETY INSTRUCTIONS

### SAVE THESE INSTRUCTIONS

You shall follow all the safety precautions mentioned in this guide when working on or with the equipment.

### General Disclaimer

---

- The information in this quick installation guide is subject to change due to product updates or other reasons. This guide cannot replace the product labels or the safety precautions in the user manual unless otherwise specified. All descriptions here are for guidance only.
- Before installations, read through the quick installation guide. For additional information, please see the user manual.
- All operations should be performed by trained and knowledgeable technicians who are familiar with local standards and safety regulations.
- Check the deliverables for correct model, complete contents, and intact appearance. Contact the manufacturer if any damage is found or any component is missing.
- Use insulating tools and wear personal protective equipment when operating the equipment to ensure personal safety. Wear anti-static gloves, clothes, and wrist strip when touching electronic components to protect the inverter from damage. The manufacturer shall not be liable for any damage caused by static electricity.
- Strictly follow the installation, operation, and configuration instructions in this guide and user manual. The manufacturer shall not be liable for equipment damage or personal injury if you do not follow the instructions. For more warranty details, please visit <https://en.goodwe.com/warranty>.

### Safety Disclaimer

---



### WARNING

#### DC Side:









1. Ensure the component frames and the bracket system are securely grounded.
2. Connect the DC cables using the delivered PV connectors. The manufacturer shall not be liable for equipment damage if other connectors are used.
3. Ensure the DC cables are connected tightly, securely, and correctly. Inappropriate wiring may cause poor contacts or high impedances, and damage the inverter.
4. Measure the DC cable using the multimeter to avoid reverse polarity connection. Also, the voltage should be under the max DC input voltage. The manufacturer shall not be liable for the damage caused by reverse connection and extremely high voltage.

#### AC Side:

1. The voltage and frequency at the connecting point should meet the on-grid requirements.
2. Additional protective devices like circuit breakers or fuses are recommended on the AC side. Specification of the protective device should be at least 1.25 times the rated AC output rated current.
3. PE cable of the inverter must be connected firmly. Make sure that all the grounding points on the enclosures are equipotential connected when there are multiple inverters.
4. You are recommended to use copper cables as AC output cables. If you prefer aluminum cables, remember to use copper to aluminum adapter terminals.

## Product:













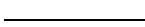



1. Do not apply mechanical load to the terminals, otherwise the terminals can be damaged.
2. All labels and warning marks should be visible after the installation. Do not scrawl, damage, or cover any label on the device.
3. Unauthorized dismantling or modification may damage the equipment, the damage is not covered under the warranty.
4. Install the inverter away from high magnetic field to avoid electromagnetic interference. If there is any radio or wireless communication equipment below 30MHz near the inverter, you have to:
  - Install the inverter at least 30m far away from the wireless equipment.
  - Add a low pass EMI filter or a multi winding ferrite core to the DC input cable or AC output cable of the inverter.
5. Warning labels on the inverter are as follows.

	<b>HIGH VOLTAGE HAZARD</b> Disconnect all incoming power and turn off the product before working on it.		Delayed discharge. Wait 5 minutes after power off until the components are completely discharged.
	Read through the user manual before any operations.		Potential risks exist. Wear proper PPE before any operations.
	High-temperature hazard. Do not touch the product under operation to avoid being burnt.		Grounding point.
	CSA marking for the United States of America and Canada		Do not dispose of the inverter as household waste. Discard the product in compliance with local laws and regulations, or send it back to the manufacturer.

## Check before Power-on

No.	Check Item
1	The product is firmly installed at a clean place that is well-ventilated and easy-to-operate.
2	The PE, DC input, AC output, and communication cables are connected correctly and securely.
3	Cable ties are intact, routed properly and evenly.
4	Unused ports and terminals are sealed.
5	The voltage and frequency at the connection point meet the inverter grid connection requirements.

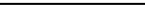
## LED Indicators

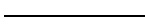
Indicator	Status	Description
		ON = Equipment power on.
		OFF = Equipment power off.
		ON = The inverter is feeding power.
		OFF = The inverter is not feeding power at the moment.
		SINGLE SLOW FLASH = Self check before connecting to the grid.
		SINGLE FLASH = Connecting to the grid.
		ON = Wireless is connected/active.
		BLINK 1 = Wireless system is resetting.
		BLINK 2 = Wireless not connect to the router.
		BLINK 4 = Wireless server problem.
		BLINK = RS485 is connected.
		OFF = Wireless is not active.
		ON = A fault has occurred.
		OFF = No fault.



## 02 Product Introduction

### PartsParts

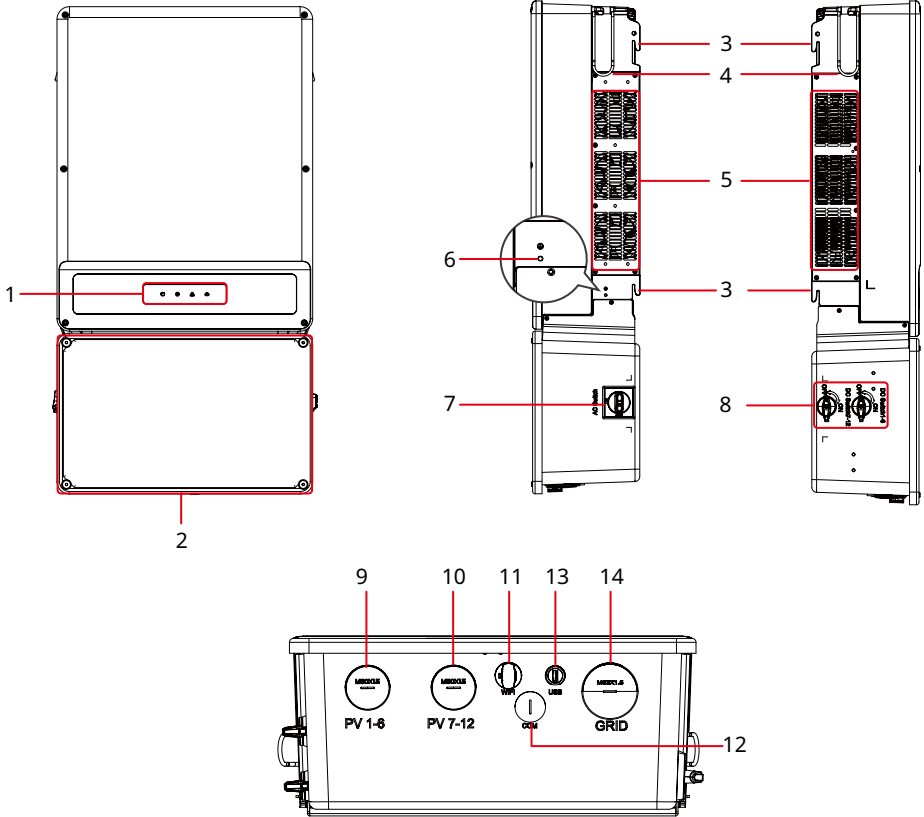

- |                                    |                                      |                                  |
|------------------------------------|--------------------------------------|----------------------------------|
| 1. LED Indicator                   | 2. Connection unit                   | 3. Mounting Plate                |
| 4. Handles                         | 5. Fan                               | 6. PE Terminal                   |
| 7. AC Switch                       | 8. DC Switch                         | 9. DC input cable hole (PV1-PV6) |
| 10. DC input cable hole (PV7-PV12) | 11. Communication Module Port (WiFi) | 12. Communication cable hole     |
| 13. USB port                       | 14. AC output cable hole             |                                  |



## Space Requirements

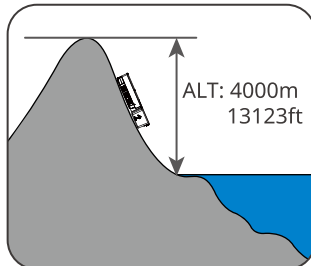
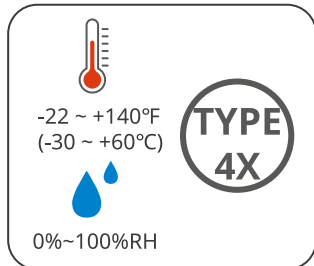
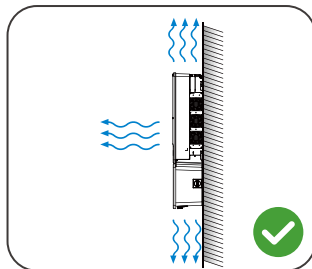
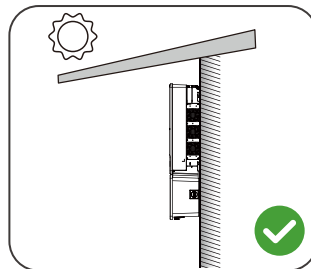
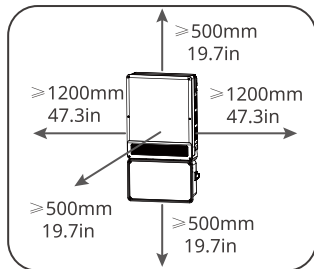
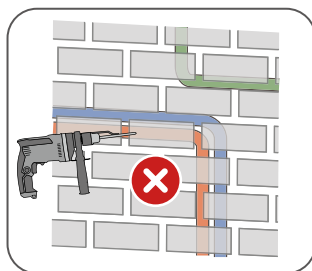

## Angle Requirements

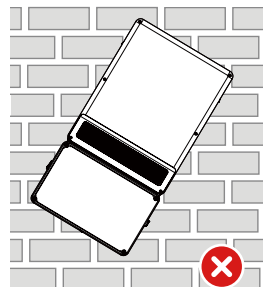
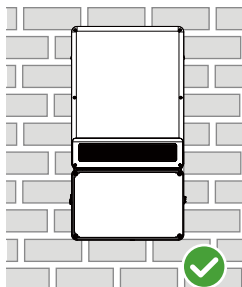
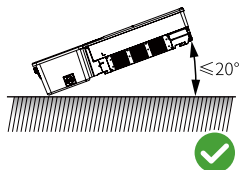
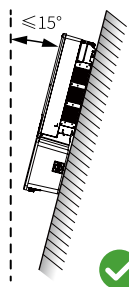

## Installing the mounting bracket

### Mounting on the wall

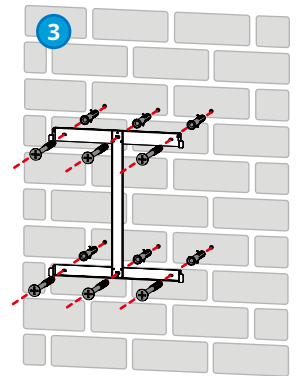
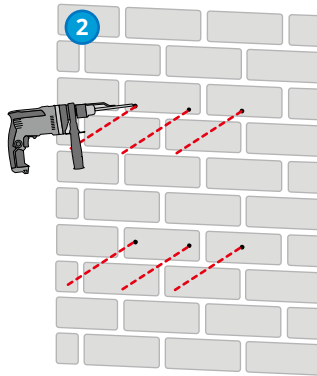
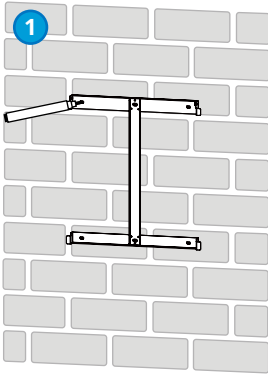

### Mounting on the plate (Contact the local sales center to purchase the bracket.)

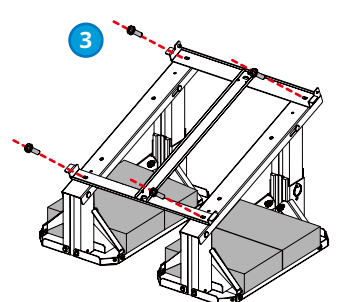
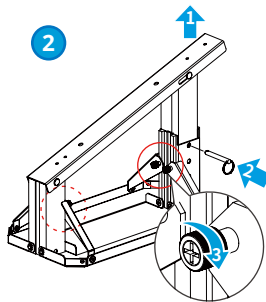
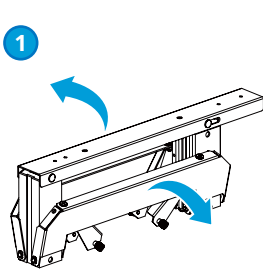

### Mounting on the plate (If you want other brackets, please prepare them by yourself.)

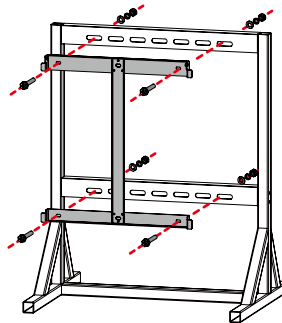

## Installing the Inverter

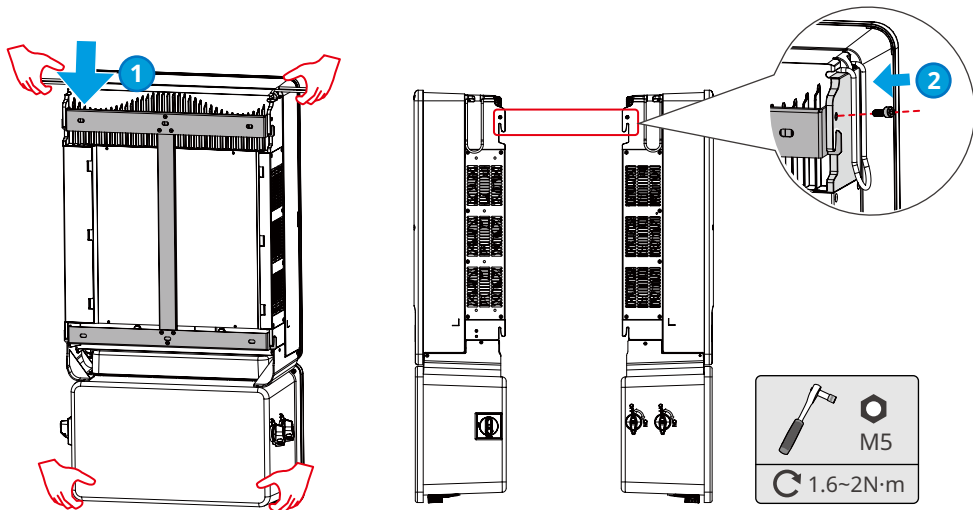

## 04 Electrical Connection

### Preparations Before Cable Connections

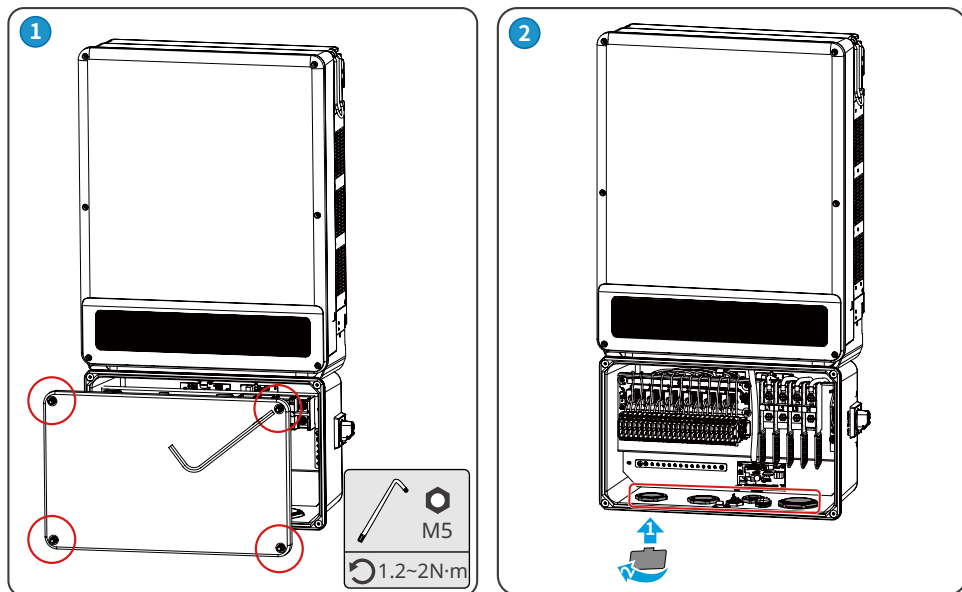

## Connection Unit Introduction

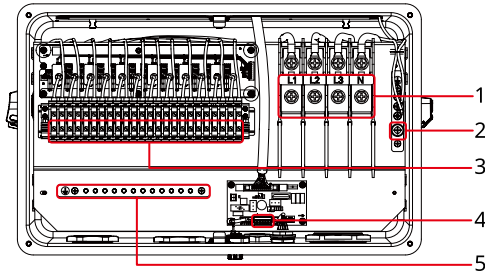

- 1. AC output terminal
- 2. PE terminal
- 3. DC input terminal<sup>[1]</sup>
- 4. Communication terminal
- 5. Grounding busbar for PV brackets

[1]: GW50K-SMT-US: 5 MPPT inputs. GW60K-SMT-US: 6 MPPT inputs.

## Conduit Hole Dimensions

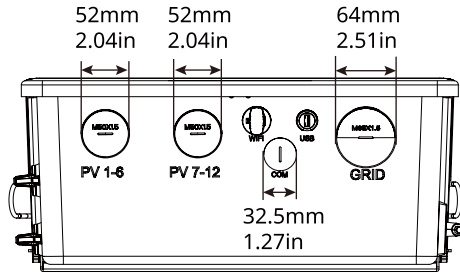

## (Optional) PE Cable

You have to prepare the grounding terminal and the screw by yourselves.

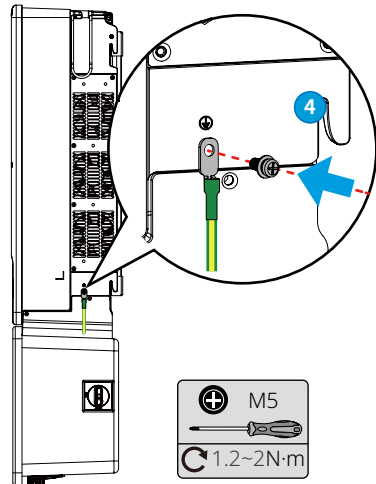
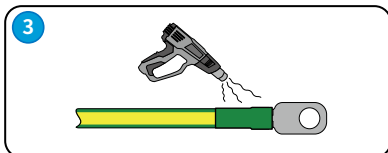
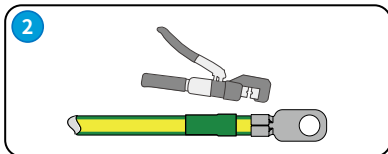
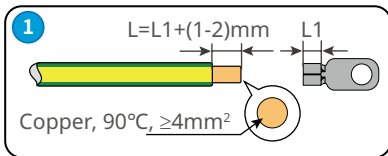

# DC Cable

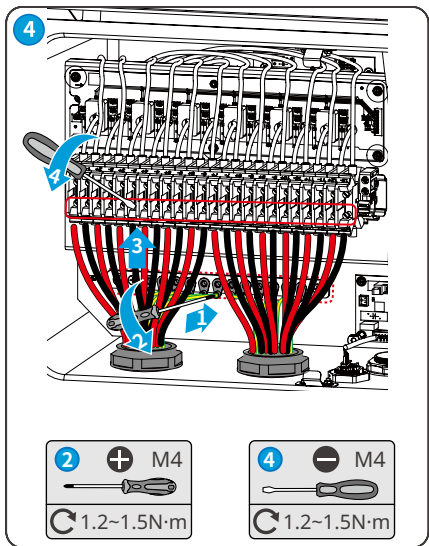
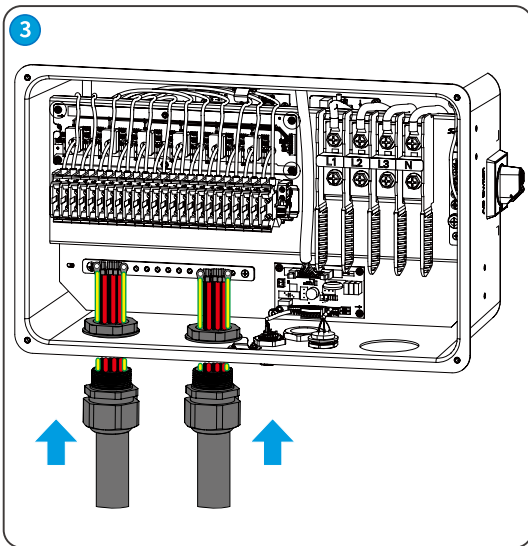
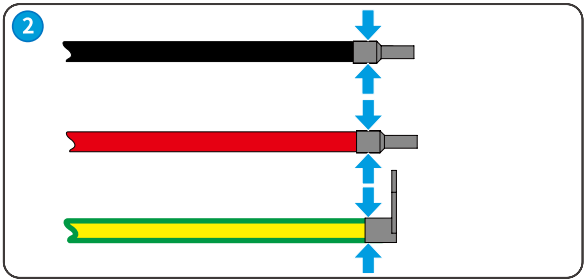
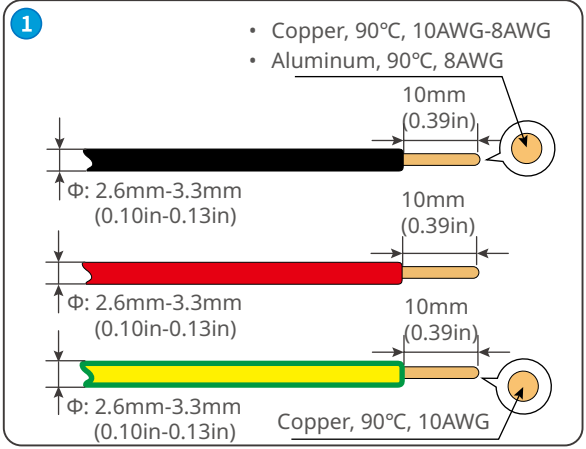
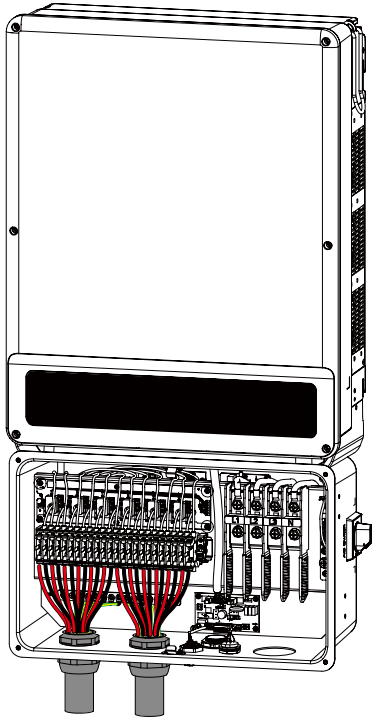

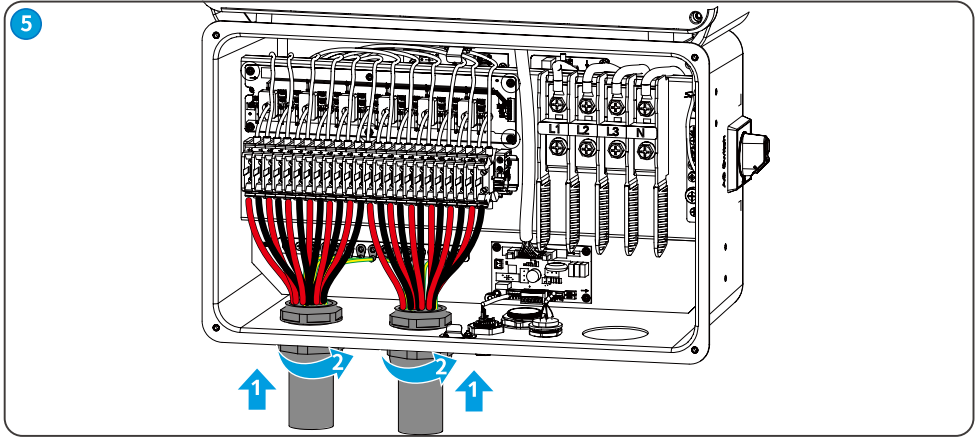

### AC Cable

You are recommended to use copper cables as AC output cables. If you prefer aluminum cables, remember to use copper to aluminum adapter terminals

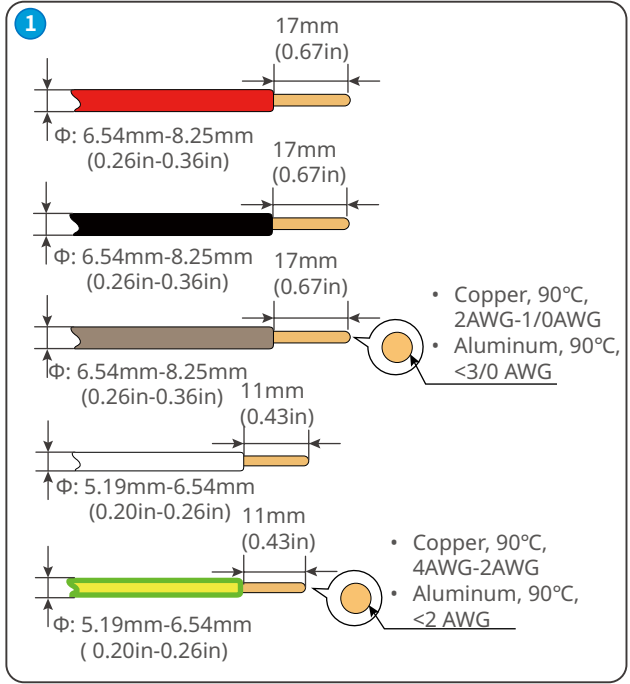
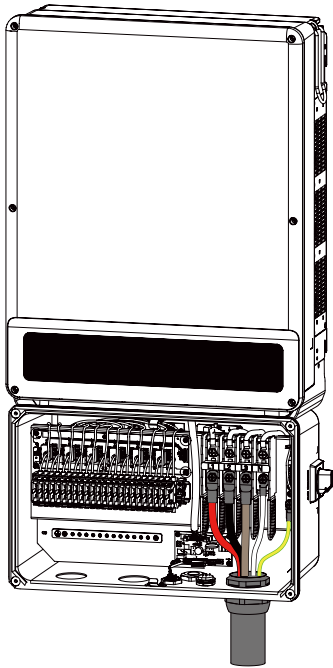



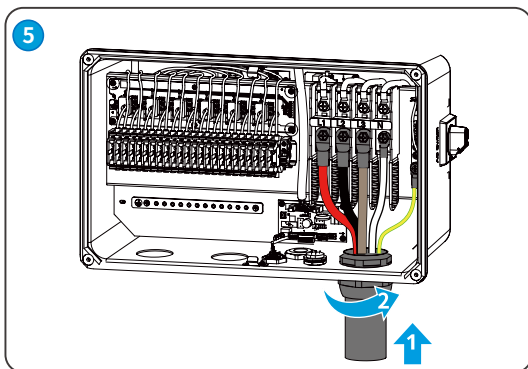
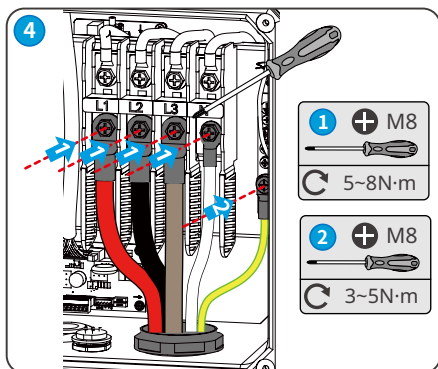
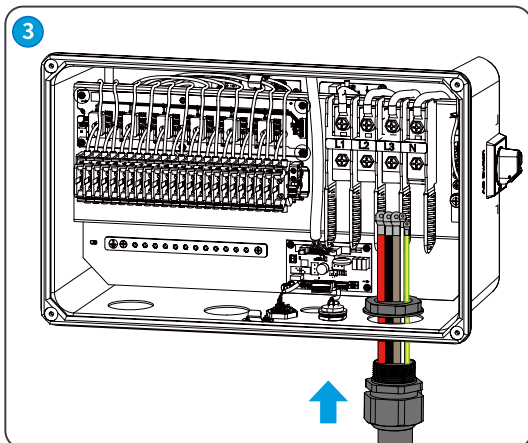
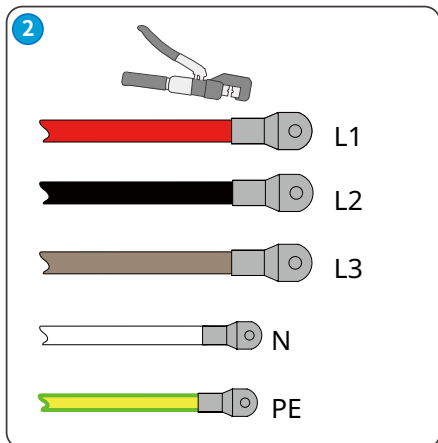

# Communication Cable

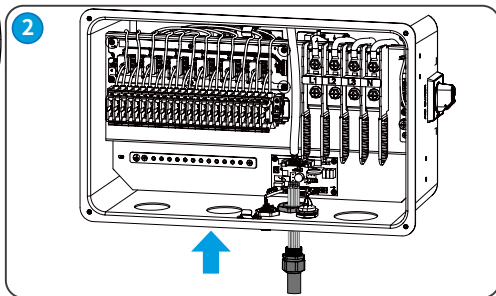
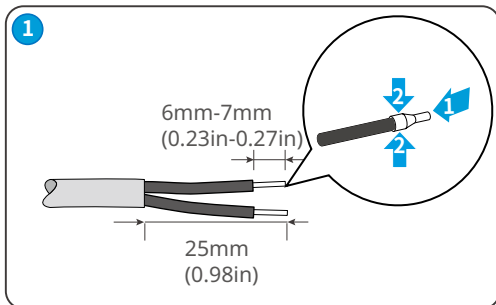
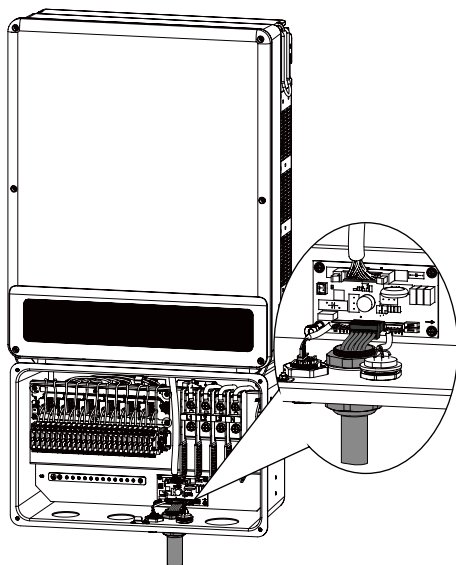

3

NO.	RS485
1	RS485 A
2	RS485 B
3	RS485 A
4	RS485 B
5	Meter A
6	Meter B

⊕ M2

⌚ 0.3~0.4N·m

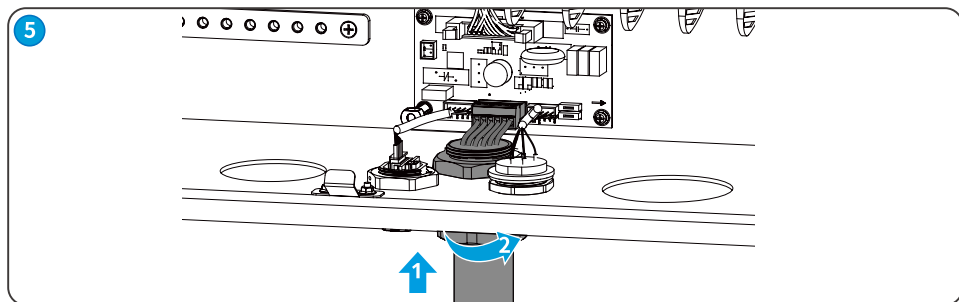
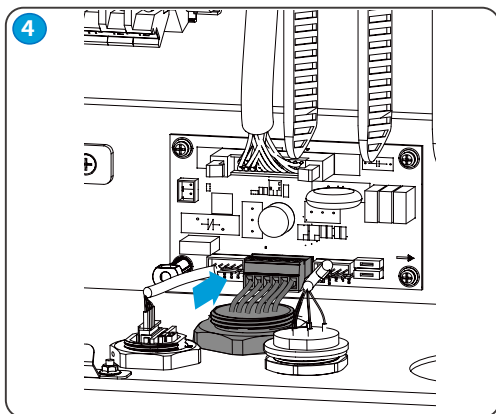

## Communication Module

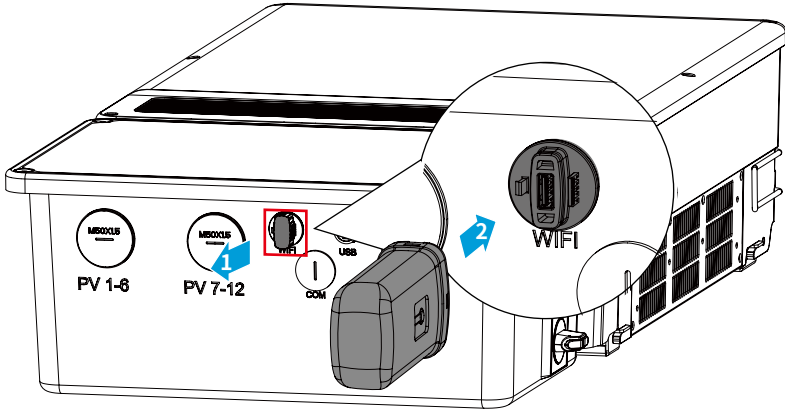

## USB Cable

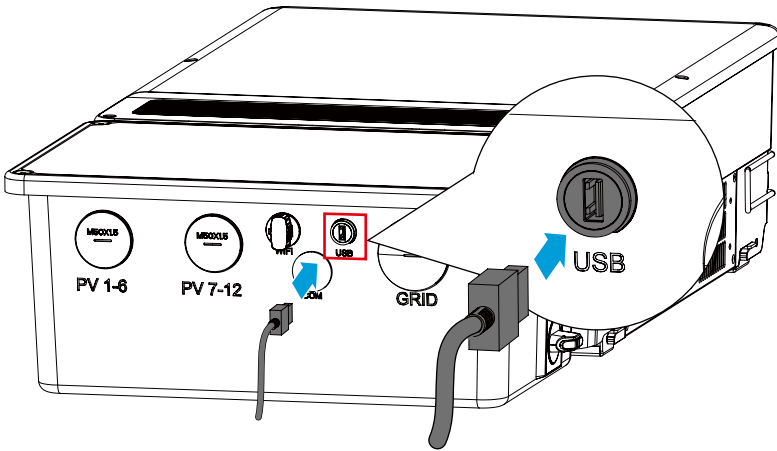

## Process After Electrical Connections

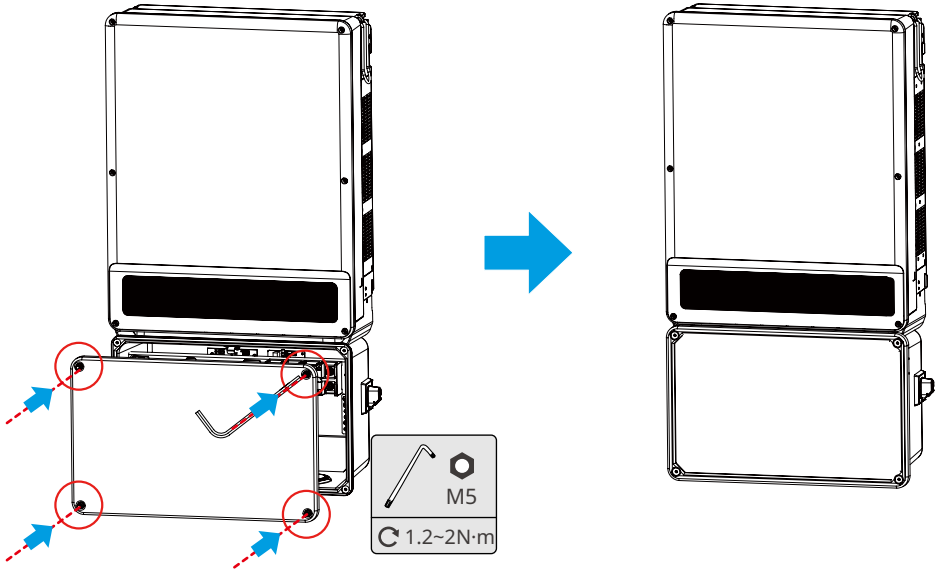

## 05 Power On and Off

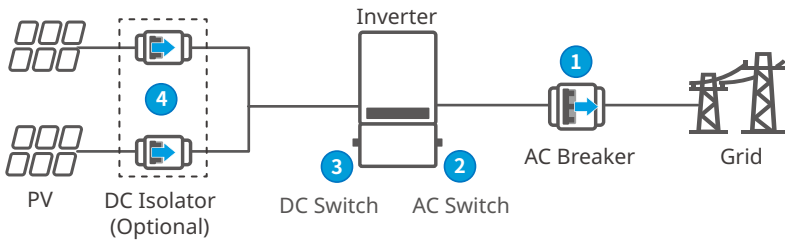

### Power ON

Turn on 1 → 2 → 3 → 4

### Power OFF

Turn off 1 → 2 → 3 → 4

### Commissioning via SolarGo App

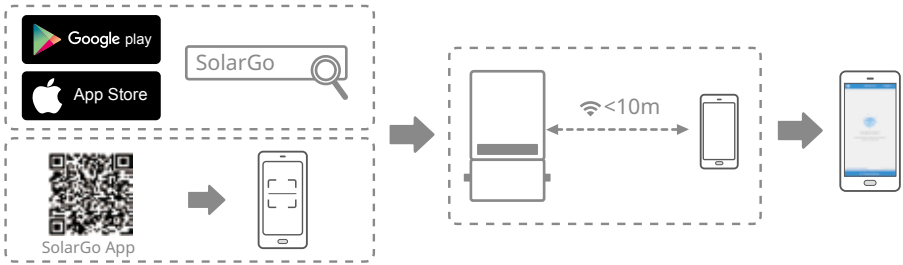

### Monitoring via SEMS Portal App

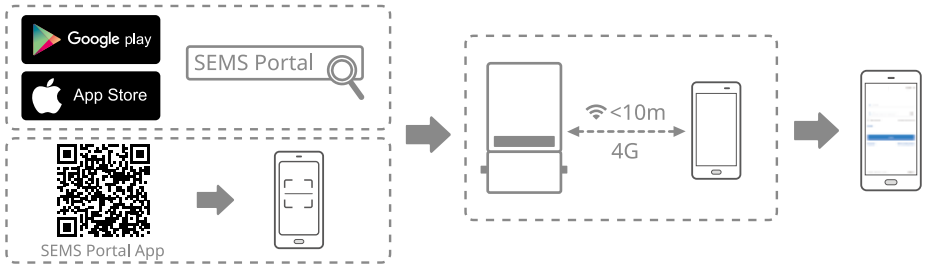

For more detailed instructions, scan the QR codes below.





Official Website

**GoodWe Technologies Co., Ltd.**

---

 No. 90 Zijin Rd., New District, Suzhou, 215011, China

 [www.goodwe.com](http://www.goodwe.com)

 [service@goodwe.com](mailto:service@goodwe.com)



340-00811-01



Local Contacts