



Art. No.

- 610853
- 609678
- 616038

Hyperion Lithium Ion Energy Storage

ORIGINAL INSTALLATION INSTRUCTIONS (EN)



Read carefully before the installation.

Keep for future reference.

Hand to next owner.

Addresses, identification and notes

Imprint

BMZ Germany GmbH
Zeche Gustav 1
63791 Karlstein am Main
Germany

Tel.: +49 6188 9956-0
Fax: +49 6188 9956-900
E-mail: mail@bmz-group.com

Product identification

Hyperion BMZ item no. 610853, 609678, 616038
Helios Battery Module item no. 607182, 612033
Model: Hyperion Lithium Ion Energy Storage
Country of Origin: Germany
Symbol: CE

Customer Service

+49 6188 9956-9830

Document identification

Original installation instructions Hyperion Lithium Ion Energy Storage
Item number: #621628
MAN-10024 | Rev: 2-2
As on: 04/10/2022
All rights reserved.

Table of Contents

1	Safety	5
1.1	Important notes on this manual	5
1.1.1	Purpose	5
1.1.2	Target group	5
1.1.3	Storage	5
1.2	Symbol explanations	5
1.2.1	Explanations regarding safety instructions and warnings	5
1.2.2	Explanation of pictograms and symbols	6
1.3	Battery application area	7
1.3.1	Appropriate use	7
1.3.2	Perilous misuse	8
1.4	Main hazards	8
1.5	Qualification of the users	8
1.6	Personal protective equipment (PPE)	9
1.7	Emergency instructions	9
1.7.1	Measures in case of fire	9
1.7.2	Measures after gases or liquids have escaped	9
1.7.3	Measures after electric shock	9
2	Product description	10
2.1	Important information about the product	10
2.1.1	Overall view	10
2.1.2	Conformity	10
2.2	Scope of delivery	11
2.3	Technical data	11
2.3.1	Performance features	11
2.3.2	Dimensions and weight of individual module	12
2.3.3	Compatible inverters	12
2.3.4	Supply, interfaces, connections	12
2.3.5	Ambient conditions	12
2.4	Status and SOC display	13
3	Commissioning	13
3.1	Safety Instructions	13
3.2	Installation	13
3.2.1	Transport	13
3.2.2	Choice of installation site	14
3.2.3	Error signalling devices	14



3.2.4	Mounting	15
3.3	Assembly	15
3.3.1	Installing Helios modular batteries	15
3.3.2	Connect Helios modular batteries next to each other in series	18
3.3.3	Closing the housing of the battery system	19
3.3.4	Adding battery modules	19
3.3.5	Disposal	19
3.4	Connecting the inverter	20
3.4.1	SMA Sunny Boy Storage 3.7 / 5.0 / 6.0	20
3.4.2	Kostal PLENTICORE plus / BI	21
3.4.3	Sungrow SH5.0RT / SH6.0RT / SH8.0RT / SH10RT	23
3.4.4	GoodWe ET PLUS+ GW5K/GW6.5K/GW8K/GW10K	24
3.5	Putting the Hyperion storage system into operation	25
4	Repair	25
5	Decommissioning, storage	25
5.1	Safety regulations	25
5.2	Storage conditions	26
5.2.1	Storage period	26
5.2.2	Physical conditions	26
5.2.3	Cleaning	26
6	Packing and transport	26
7	Disposal	27
8	Appendix	28
8.1	BMS master, DC-DC converter and relay in Hyperion	28
8.2	Assignment BMS master inverter interface (X2)	28
8.3	Adjusting system voltage with SMA SB Storage	29
9	Further directories	30
9.1	Glossary	30
9.2	List of tables	30
9.3	List of figures	30



1 Safety

Before installing the battery system, read these instructions carefully.

Please follow the safety and warning instructions carefully to avoid damage to persons, objects and the environment.

 	⚠ CAUTION
	<p>Risk of burns if you fail to adhere to the safety instructions.</p> <p>During operation, heat can be generated by live parts, overload, arc or short circuit. Touching hot surfaces can cause minor burns.</p> <p>▶ Read the operating instructions carefully before using the modular battery.</p>

1.1 Important notes on this manual

1.1.1 Purpose

This document describes the installation of a BMZ Hyperion battery system in combination with SMA Sunny Boy Storage 3.7/5.0/6.0, SMA Sunny Tripower 5.0/6.0/8.0/10.0 Smart Energy, Kostal PLENTICORE plus/BI, Sungrow SHR 5.0/6.0/8.0/10RT or the GoodWe ET PLUS+ series.

1.1.2 Target group

The installation instructions are intended exclusively for qualified electricians.

1.1.3 Storage

This manual is part of the battery. For a safe installation, the manual must be accessible to the installers.

- ▷ Keep this manual near the battery.
- ▷ Pass this manual on to the next owner of the battery.

1.2 Symbol explanations

1.2.1 Explanations regarding safety instructions and warnings

Safety instructions are universally valid and can be found in a safety chapter or at the beginning of a chapter.

Safety Instructions

Warnings







Warnings are placed directly before the instructions of the respective action. They help you to avoid dangers during the upcoming action. They consist of the following elements:







Table 1: Warnings

Warning triangle	indicates all hazards with regard to death or injury along with a signal word.
Signal word	<div style="background-color: #800000; color: white; padding: 5px; text-align: center;"> DANGER </div> <p>denotes a hazard with a high degree of risk. Failure to avoid exposure to it will result in death or serious injury.</p> <div style="background-color: #FF4500; color: white; padding: 5px; text-align: center;"> WARNING </div> <p>denotes a hazard with a medium degree of risk. Failure to avoid exposure to it can result in death or serious injury.</p> <div style="background-color: #FFD700; color: black; padding: 5px; text-align: center;"> CAUTION </div> <p>denotes a hazard with a low degree of risk. Failure to avoid exposure to it can result in a minor injury.</p> <div style="background-color: #0056B3; color: white; padding: 5px; text-align: center;"> NOTICE </div> <p>indicates hazard concerning objects. Failure to avoid exposure to it can result in damage to property.</p>
Type and source of the danger	states the nature of the danger and what causes it
Consequence	indicates what can happen if you do not follow the warning
Call for action	<p style="text-align: center;">▶ describes what you must do to protect yourself from the danger</p>
Additional symbols, pictograms	can be used in addition to the warning triangle. Warning signs (yellow) indicate the danger. Prohibition signs (red) and mandatory signs (blue) represent remedial measures.

1.2.2 Explanation of pictograms and symbols

Table 2: Explanation of the symbols used

Symbols	Declaration
	General warning sign. Note additional information.
	Warning of dangerous voltage
	Warning of dangers from batteries that are being charged
	Warning of flammable substances
	Hot surface warning
	Warning of hand injuries

	No access for persons who have pacemakers or implanted defibrillators
	Manual lifting prohibited.
	General commandment sign Note additional information.
	Adhere to instructions.
	Use foot protection.
	Use hand protection.
	Do not dispose of batteries with household garbage.

1.3 Battery application area

1.3.1 Appropriate use

Battery system

The Hyperion Lithium Ion Energy Storage is a battery system. It serves as an energy storage device within an electricity storage system for private households and small businesses. It enables you to temporarily store self-produced electricity, e. g. from photovoltaic - or CHP (cogeneration of heat and power) plants. The electricity can later be used when needed.

In a battery system, 3 to 6 Helios modular batteries can be connected to one another in series.

BMZ GmbH is not liable for personal injury and/or material damage due to improper use of the energy storage system.

Limits

The battery system is a self-contained unit which is only functional after proper installation with an approved inverter.

A maximum of 6 modular batteries can be connected serially in the Hyperion battery system.

In order to avoid dangers such as water pipe bursting, the modular batteries must be stored at least 15 cm above the floor. Proper installation of the Hyperion fire pump ensures that the active electrical components are at least 15 cm above the floor.

The Hyperion battery system may:

- only be used with Helios modular batteries.
- only be used with compatible inverters.
- only be used in closed rooms.
- only be used in an undamaged condition and in accordance with the operating instructions.

Any other usage is not intended.

1.3.2 Perilous misuse

- Do not use the battery system with other modular batteries.
- Do not use the battery system outside its performance limits.
- Do not install the battery system in rooms at risk of flooding.
- Do not connect the battery system to devices not approved for this purpose.
- Do not open modular batteries. The modular battery may only be opened by trained service personnel of BMZ GmbH.

1.4 Main hazards

You can expect zero danger from the battery under normal conditions. The battery corresponds to the state of the art in science and technology. However, it is impossible to completely exclude risks if the battery is misused or in the event of technical failure. In case of lithium-ion batteries, these generally include fire, explosion, chemical burns, and electric shock.

The product-specific risk of hazards is elevated by

- water (e. g. flooding),
- heat exposure (> 70 °C), and
- failure or malfunction of the control system due to electromagnetic radiation.



Electric shock

Touching live components may cause an electric shock when modular batteries are connected in series. The electric shock can have thermal or muscle paralyzing effects. The latter can lead to ventricular fibrillation, cardiac arrest or respiratory paralysis, or death.



Fire

Overload, short circuit or arcing can cause a lithium-ion fire with thermal runaway. People can be hit by electrolyte or molten material. In the event of fire, there is a risk of suffocation due to lack of oxygen and a risk of poisoning due to toxic fumes.

1.5 Qualification of the users

Only the electricians qualified by BMZ GmbH or BMZ GmbH itself may install the battery system.

Children

Do not leave the children unattended or allow them to be near the battery system.

People with implants

High currents have effects on medical implants.

- ▶ People with implants must be careful not to be in the direct vicinity of the battery during operation.

1.6 Personal protective equipment (PPE)

Use foot protection and hand protection during assembly.

1.7 Emergency instructions

1.7.1 Measures in case of fire

- ▶ Do not inhale smoke and vapours.
- ▶ Report a lithium-ion fire to the fire department.
- ▶ If possible: close the doors.
- ▶ If possible: cool the modular battery with water. Avoid contact with the extinguishing water!

1.7.2 Measures after gases or liquids have escaped

Escaping gases can cause respiratory problems.

- ▶ Ventilate immediately or go out into the fresh air, in more extreme cases, call a doctor immediately.

Inhalation**Skin contact**

Skin contact may cause skin irritation.

- ▶ Wash skin thoroughly with soap and water.

Eye contact

Eye contact may cause irritation to the eyes.

- ▶ Immediately rinse eyes thoroughly with water for 15 minutes, then consult a doctor.

1.7.3 Measures after electric shock

Ensure that the system is at zero voltage.

- ▶ **For unconscious patients:** Ensure respiration and cardiovascular function. If necessary, initiate cardiopulmonary resuscitation immediately.
- ▶ **For responsive patients:** Cool burn injuries and cover them by dressing the wound.

2 Product description

2.1 Important information about the product

2.1.1 Overall view

Figure 1: Overall view of battery system

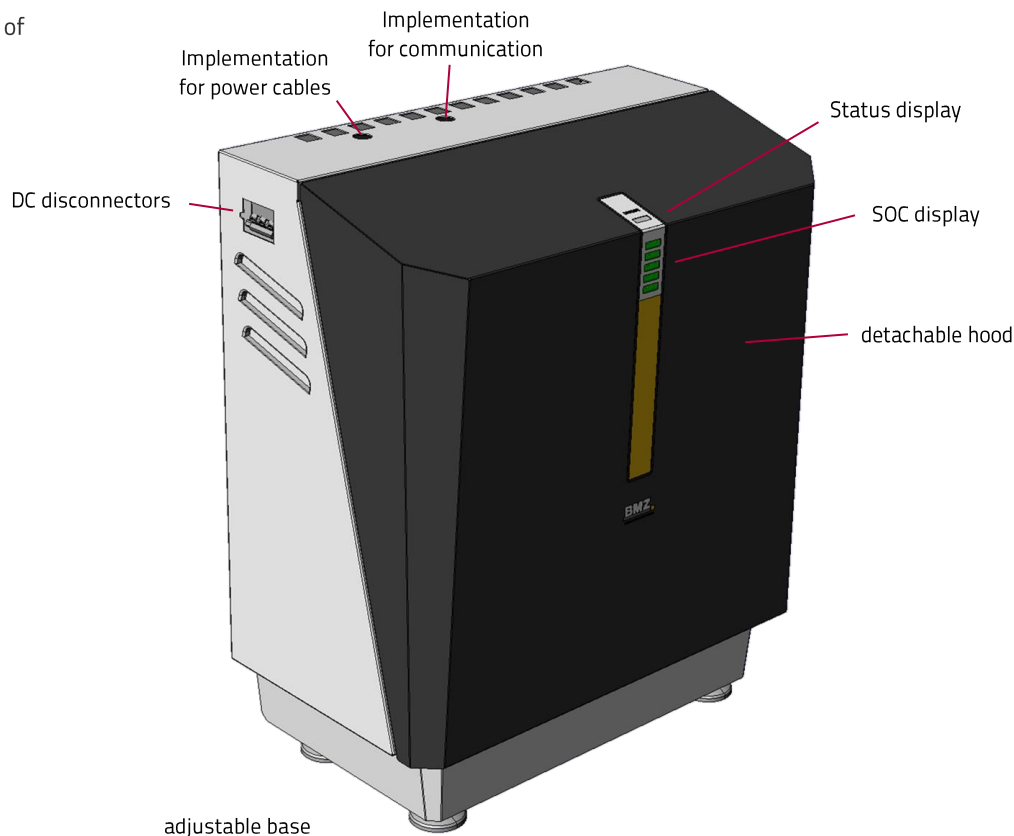

2.1.2 Conformity

The following standards, laws and guidelines were taken into account during the development of the modular battery:

- EU directive with CE labelling obligation
 - Low Voltage Directive 2014/35/EU
 - EMC Directive 2014/30/ EU
- Legal requirements
 - UN transport test (lithium systems)
- Standards and user guidelines
 - DIN EN 60730
 - DIN EN 62619

2.2 Scope of delivery

- Hyperion system housing
- Installation kit (in system housing) is included:
 - 7 RJ45 patch cables A
 - 12 screws M5x10 B
 - 3 Dummy sockets, power plugs C
 - 2 PG connections D
 - 1 Three-hole cable bushing E
 - 1 Single-hole cable bushing F
 - 1 Snap Ferrite G
- Installation instructions
- 3 to 6 Helios modular batteries

Figure 2: Installation kit

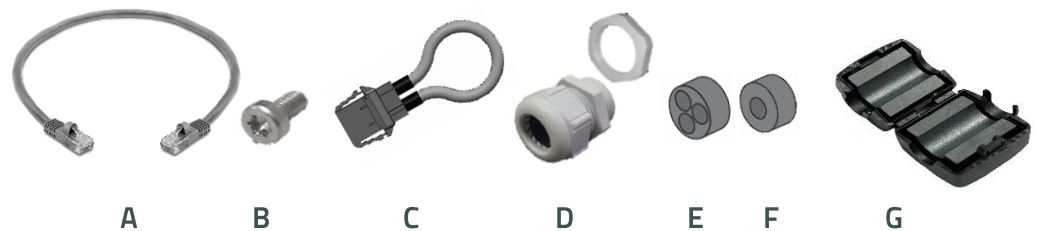

2.3 Technical data

2.3.1 Performance features

Table 3: Technical data

Modules in series	3	4	5	6
Energy content (nom./usable)	9.7 kWh / 7.5 kWh	12.9 kWh / 10 kWh	16.1 kWh / 12.5 kWh	19.3 kWh / 15 kWh
Nominal voltage	154 V	206 V	257 V	308 V
End-of-charge voltage	177 V	228 V	285 V	342 V
Final discharge voltage	139 V	185 V	231 V	277 V
Capacity (usable)	48.7 Ah	48.7 Ah	48.7 Ah	48.7 Ah
Charging current (max.)	29 A	29 A	29 A	29 A
Discharge current peak	40 A	40 A	40 A	40 A
Discharge power peak	6.2 kW	8.2 kW	10.3 kW	12.3 kW
Discharge power (max.)	4.6 kW	6.2 kW	7.7 kW	9.3 kW
Weight	107 kg	129 kg	151 kg	173 kg
Dimensions (W x H x D)	751 mm x 870 mm x 423 mm			
Discharge operating temperature	-15 to 55 °C			
Load operating temperature	0 to 45 °C			
Storage temperature	-20 to 60 °C			
Battery chemistry	Li-Ion NCA/NMC			
Discharge depth	77 % DOD [in relation to nom. capacity]			
Full Cycles	5,000 or 3,000 (for residual capacity of 60 % or 80 %)			

2.3.2 Dimensions and weight of individual module

- Dimensions (W x H x D): 546.1 mm x 216.8 mm x 155.25 mm
- Weight: 22 kg

2.3.3 Compatible inverters

- SMA Sunny Boy Storage 3.7/5.0/6.0 (CAN)
- SMA Sunny Tripower 5.0/6.0/8.0/10.0 Smart Energy (CAN) from Q4 2022
- Kostal PLENTICORE plus/ BI (RS-485)
- Sungrow SH 5.0/6.0/8.0/10RT (CAN) from Q1 2023
- GoodWe ET PLUS+ GW5K/GW6.5K/GW8K/GW10K (CAN)

2.3.4 Supply, interfaces, connections

Battery system

The battery system is supplied with the following connections:

- + DC cable: AWG8 red
- - DC cable: AWG8 black
- Cable for grounding: AWG8 yellow-green
- Communication cable, either CAN or RS-485

All power cables are about 1,5 m long, the communication cable measures 5,4 m. It could be necessary to shorten the cables.

NOTICE: When extending the power cables, do not exceed these lengths:

- 6 mm² cross section: 5 m
- 10 mm² cross section: 8 m

Modular battery

The modular battery has one socket which contains (+) and (-) as power contacts and two RJ45 sockets which contain CAN bus and status and signal lines:

- 1 socket with power contacts (+) and (-)
- 1 RJ45 sockets with CAN bus connection for monitoring and control of the modular battery by the higher-level controller (IN)
- 1 RJ45 socket for connecting a further modular battery (OUT)
- 2 M5 threads for connecting the grounding

2.3.5 Ambient conditions

Operation

Operation exclusively inside buildings (air-conditioned and non-air-conditioned interiors):

- Temperature: 0 ... 45 °C
- Relative humidity: 5 ... 85 %
- Height: 0 ... 2000 m above sea level









Storage

- Temperature storage: -20 ... 60 °C

2.4 Status and SOC display

During operation 6 LED fields indicate status and SOC of the battery system.

Table 4: Overview LED status codes

LED	10 seconds ⇒	Status
Green – on		Discharge mode
Green - flashes (0,5 s on / 1 s off)		Ready (battery relay engaged - waiting for charge or discharge)
Green – flashes slowly (1 s on / 5 s off)		Standby (battery system relay open)
Blue - on		Charging mode
Blue - flashes (0,5 s on / 1 s off)		Diagnosis or shutdown of the battery system
Blue - flashes slowly (1 s on / 5 s off)		System start, relay test or software update
Red - flashes quickly (0,2 s on / 0,2 s off)		System error - System has disconnected battery from inverter
Red – flashes (0,5 s on / 1 s off)		Error during start-up of the battery system - battery remains disconnected

3 Commissioning

3.1 Safety Instructions

Guidelines

The installation may only be carried out by qualified electricians according to IEC 60204-1 (International Electrotechnical Commission).

Handling, transport

The housing including electronics weighs 41 kg. One modular battery weighs 22 kg. Heavy lifting can cause a disturbance of the musculoskeletal system.

- ▶ Lift the Hyperion cover (11 kg) and base (30 kg) separately.
- ▶ If necessary, do not lift the Hyperion base alone or be sure to use transport aids.



Risk of crushing and abrasions when lifting and inserting the modular batteries.

- ▶ Use foot and hand protection.

3.2 Installation

3.2.1 Transport

Installation site difficult to access

If the installation site is difficult to access, it is recommended that the base and the hood of the system housing be carried to the installation site separately:

1. Open the packaging of the Hyperion system housing.
2. Unscrew 2 screws (4 mm Allen key) at the front of the bottom of the system housing.
3. Remove the hood from the system housing base.
4. Carry the hood and base to the installation site individually.

Modular batteries

The modular batteries should be transported to the installation site in their original packaging.

3.2.2 Choice of installation site

The battery system can be mounted upright on the floor or in a hanging position on the wall. It should not be installed in areas, which have a risk of fire and or explosion. The battery system should be installed on non-flammable flooring.

Recommendation

It is recommended that the battery system be installed on the floor against a wall, where the inverter can be mounted centrally above it. The inverter should be mounted at least 20 cm above the battery system. At a distance of up to 1,5 m to the connectors, the cables already attached to the Hyperion can be used.

Leave space of at least 30 cm free to the left and right of the battery system to get to the DC disconnect switch to ensure sufficient air circulation.

Securing against tipping over

To prevent the battery system from tipping over, it can be secured to the wall with two screws (not supplied). Two fixing points are provided in the system housing for this purpose.

Wall hanging mounting

Four fixing points are provided in the system housing for wall mounting. Since the battery system can weigh up to 173 kg, it must be checked in advance whether the wall and fastening material are suitable to support the load in the long term.

NOTICE To access the two upper fastening points, it is recommended to remove the BMS Master before attaching the screws.

3.2.3 Error signalling devices

The battery as well as the connected inverters signal battery faults visually (red signal).

Since the battery system is usually operated unattended, a smoke detector, certified according to DIN EN 14604, must be installed in the installation room so that a fire is quickly detected in an emergency.

In addition, a contact on the inverter (depending on the type) can be used to connect optical and/or acoustic signal transmitters which are activated in the event of battery faults (e.g. overtemperature).

NOTICE If external optical/acoustic signal transmitters are to be used, it must be clarified in advance whether the inverter has a corresponding signal contact or can be retrofitted with one.

3.2.4 Mounting

Requirement

The installation location for the battery system and the inverter have been determined.

Instructions

Recommended mounting:

1. Install the wall bracket of the inverter.
2. Hook the inverter into its bracket.
3. If necessary, unscrew the cover of the connection area.
4. If not already done, remove the cover from the battery system housing:
 - ⇒ Unscrew 2 screws (4 mm Allen key) on the front bottom.
 - ⇒ Remove the cover from the base.
5. Position the base of the battery housing at the intended installation location (and screw on if necessary).

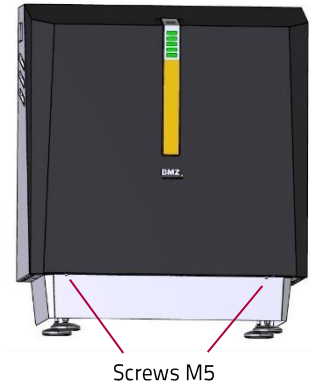

3.3 Assembly

3.3.1 Installing Helios modular batteries

Safety Instructions

	<p style="text-align: center;">⚠ CAUTION</p> <p>Risk of crushing due to improper installation. Falling or improper insertion of the module can cause slight bruising and abrasions to hands and feet.</p> <ul style="list-style-type: none"> ▶ Wear protective clothing.
	<p style="text-align: center;">⚠ CAUTION</p> <p>Ergonomic hazards due to heavy lifting. Lifting the modular battery can cause a disturbance of the musculoskeletal system.</p> <ul style="list-style-type: none"> ▶ Should it be necessary, be sure not to lift the module alone. ▶ Use a lifting aid, when necessary.

NOTICE

Incorrect installation due to damaged or contaminated modular batteries.

Only faultless modules may be mounted. The housing must be undamaged. The contact points must be undamaged and clean.

- ▶ Perform a visual inspection.
- ▶ Clean the contact points with a dry cloth if necessary.

The modular battery may only be inserted into the Hyperion battery system provided for this purpose.

Requirements

- ✓ The power storage system is securely installed.
- ✓ The main switch of the power storage system is off.
- ✓ The modular batteries must have a similar voltage.
- ✓ The inverter is switched off or not connected yet.

Instructions

1. Make sure that the DC disconnecter of the Hyperion is set to "off".
2. Loosen the two screws H and I, with which the downholder is fixed on the left and right, and lift up the downholder.

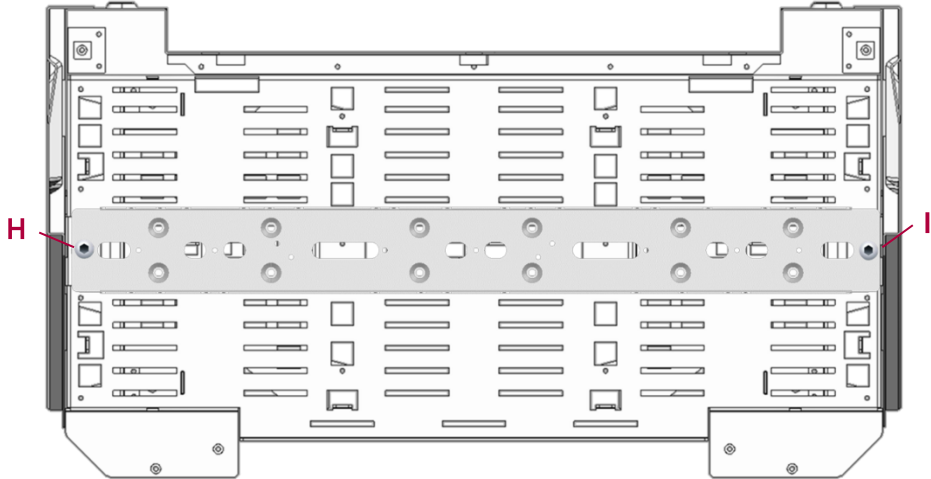

3. Unpack and insert the modular batteries. **NOTICE:** To ensure the best possible cooling; we recommend that the modular batteries are inserted as in **Figure 3**.

Figure 3: Insert 3 to 6 Helios modular batteries

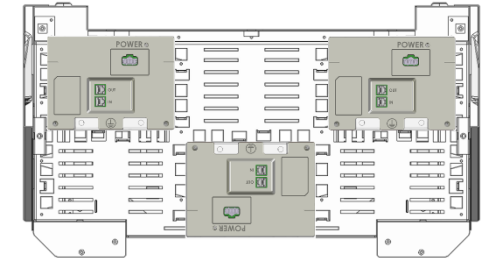

3 Helios modular batteries



4 Helios modular batteries



5 Helios modular batteries

6 Helios modular batteries

4. Screw the downholder to the right and left of the base of the system housing.
5. Screw each modular battery with two screws (M6) to the downholder/grounding support.
For example, refer to Figure 4.

Figure 4: Modular batteries fixed to the grounding support

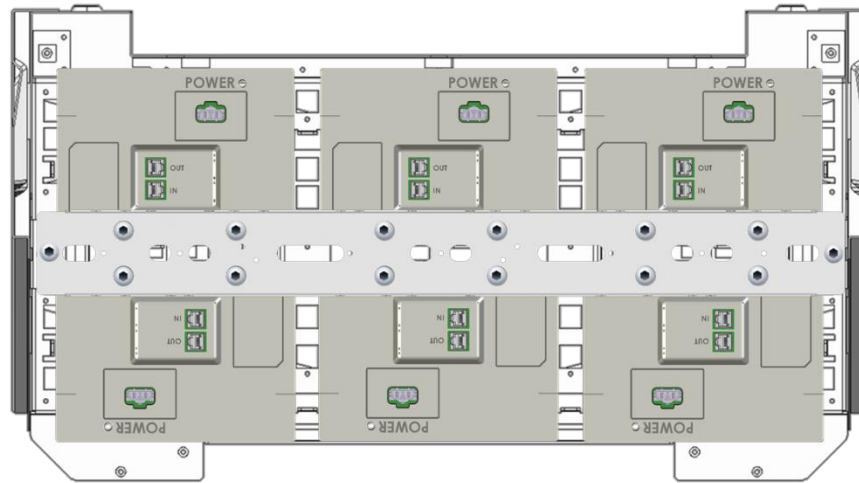

6. Use the patch cables to connect the BMS master (left of the two RJ45 sockets) with the installed modular batteries.
For example, refer to Figure 5.

Figure 5: Connecting the modules to the BMS master with patch cables

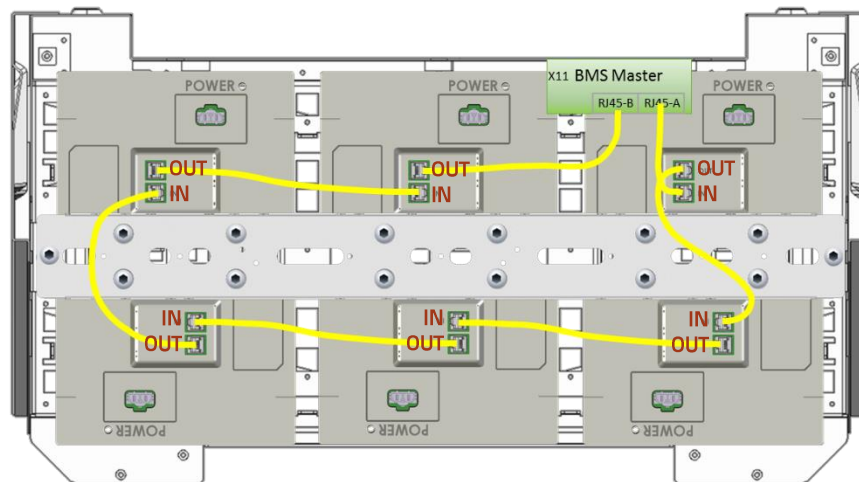

7. Connect the last module with the master's left RJ45 socket (RJ45-B).

3.3.2 Connect Helios modular batteries next to each other in series

	⚠ WARNING
<p>Electric shock from live parts.</p> <p>Touching live components may cause electrical shock, which may create intense heat or paralyse muscles. The latter can lead to ventricular fibrillation, cardiac arrest or respiratory paralysis, or death.</p> <p style="text-align: center;">▶ Never touch the contacts.</p>	

1. Remove the safety cover of the "Power" sockets.
2. Insert the power plug for the respective modular battery until it clicks into place. For example, refer to **Figure 6**.

Figure 6: Power path with switching devices and BMS

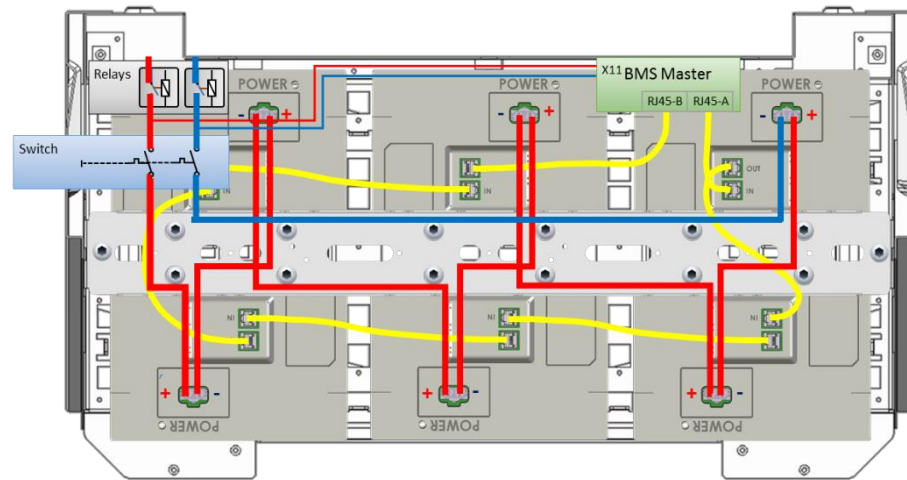

3. Check by pulling the power plugs to make sure that the latching is engaged.
4. If there are less than 6 modular batteries: fit the power plugs not required with the dummy sockets **C** supplied.
5. Feed the power cables (red and black) as well as PE (yellow-green) through the left hole in the basic housing and fix them with the supplied PG screw connection.

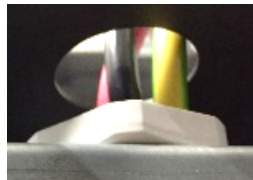

NOTE First lead the cables through the union nut of the PG gland and then through the outer housing.

6. Above the left PG gland, lead the red (+) and black (-) cable through the supplied folding ferrite **G**.
7. Lead the communication cable through the right hole and fix it with the supplied cable gland.
8. Check that the power cables are firmly attached to the relay. If not, tighten the M4 nuts with 1.5 Nm.



3.3.3 Closing the housing of the battery system

1. Position the housing hood (with display) in front of the housing base and plug the cable for the display on the board into the hood.
2. Insert the hood into the guide at the top and close it at the bottom with the two M5x10 screws (4 mm Allen key) which were unscrewed in 3.2.3.

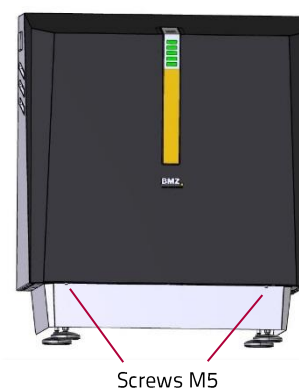

3.3.4 Adding battery modules

1. Check the voltage of the new modules. The voltage should be between 46 V and 56 V.
2. Adjust the voltage of the battery system to ± 1 V to the voltage of the new modules (see Appendix 8.3). An exactly adjusted module voltage avoids adjustment in the system and allows immediate access to the full capacity.
3. Disconnect the inverter from voltage and switch off Hyperion.
4. Install the new modules. See chapter 3.3 Assembly.
5. Put the system into operation. See chapter 3.4.

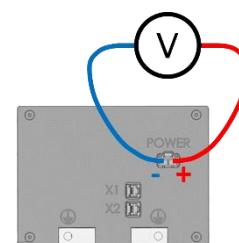

3.3.5 Disposal

Dispose of transport packaging for recycling in accordance with the statutory provisions.

It is recommended to keep not required parts (patch cables, dummy plugs, screws) together with the installation instructions near the battery system.

Before removing defective modular batteries, the power socket must be taped with insulating tape after removing the power plug.

3.4 Connecting the inverter

3.4.1 SMA Sunny Boy Storage 3.7 / 5.0 / 6.0

Instructions

1. Feed the DC power cable, PE as well as the communication cable(s) through the respective PG screw glands into the connection compartment of the inverter.

Figure 7: Connecting the SMA SB Storage to the BMZ Hyperion

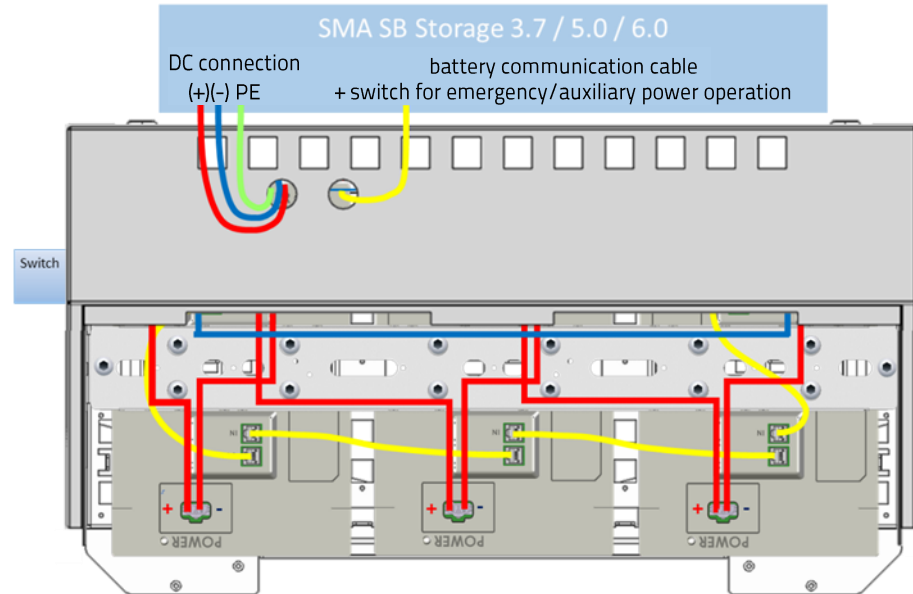

2. Connect the cables in the inverter according to the Sunny Boy Storage 3.7 / 5.0 / 6.0 operating instructions.

⇒ Chapter 6.5: Connecting battery communication cable:

- yellow: CAN H (E)
- white: CAN L (D)
- orange: Enable (B)
- blue: GND (C)



⇒ Chapter 6.1.2: Interior View +

Chapter 6.8.3: Connect power cables

- Yellow-green grounding point for grounding the battery (L)

⇒ Chapter 6.8 DC connection

- Red (+) (A+)
- Black (-) (A-)

It is recommended to use all bridges (30 A)

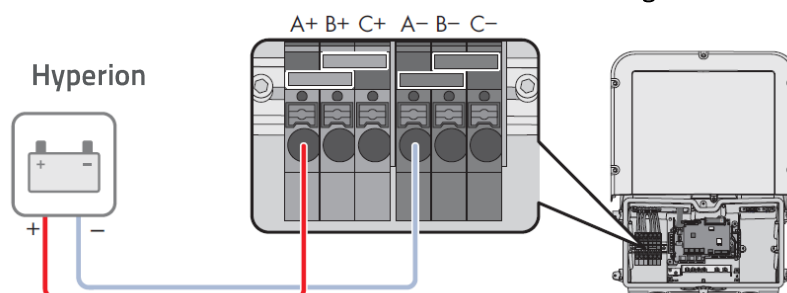

3. Check all electrical connections
4. Close the housing of the inverter.

NOTICE on operation with SMA Sunny Boy Storage 3.7 / 5.0 / 6.0:

For full functionality, firmware 3.11.16 or newer must be installed on the inverter.

3.4.2 Kostal PLENTICORE plus / BI

1. In order to operate the Hyperion storage system communicatively with the Kostal PLENTICORE plus, the communication must be switched to RS485.
 - ⇒ Disconnect the X2 plug from the BMS master (green plug at top left).
 - ⇒ Pin the yellow wire from PIN1 to PIN3 (RS485+).
 - ⇒ Pin the white wire from PIN2 to PIN4 (RS485-).
 - ⇒ Bridge PIN7 and PIN8 to activate the RS485 communication.
 - ⇒ Plug X2 back into BMS master.

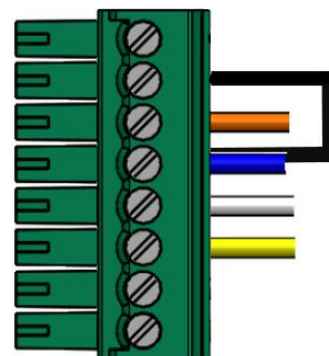

2. Preparation: Ground the Hyperion housing:
 - ⇒ PE
 - Yellow-green Connect to grounding rail

Figure 8: Connecting the PLENTICORE plus / BI to the BMZ Hyperion

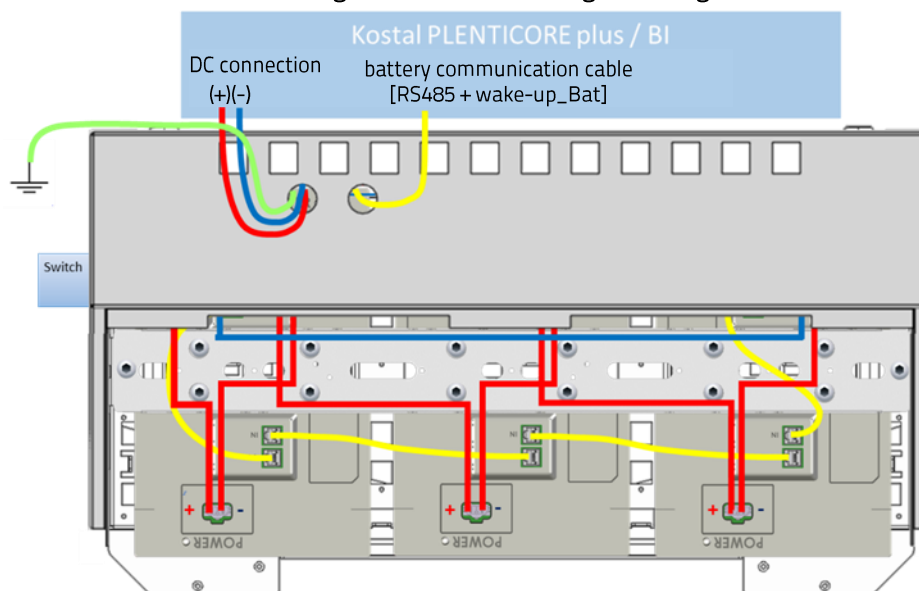

3. Feed the communication cable through the respective PG screw connections into the connection compartment of the inverter.
4. Connect the cables in/on the inverter according to the PLENTICORE plus operating instructions.

⇒ Connecting battery communication cable:

- white: RS485B
- yellow: RS485A
- blue: GND 0V
- orange: VDD +12-14V

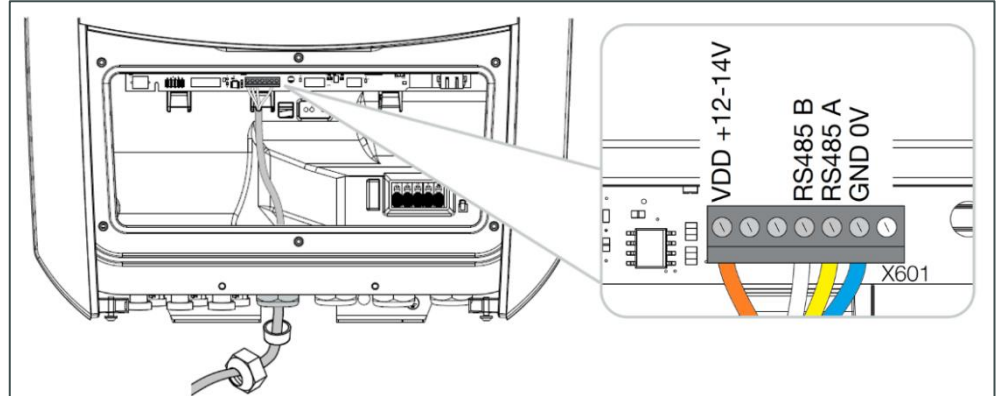

5. Shut the inverter down

6. Establish DC connection:

⇒ Attach Sunclix plug accordingly

- Red (+) (DC3 +)
- Black (-) (DC3 -)

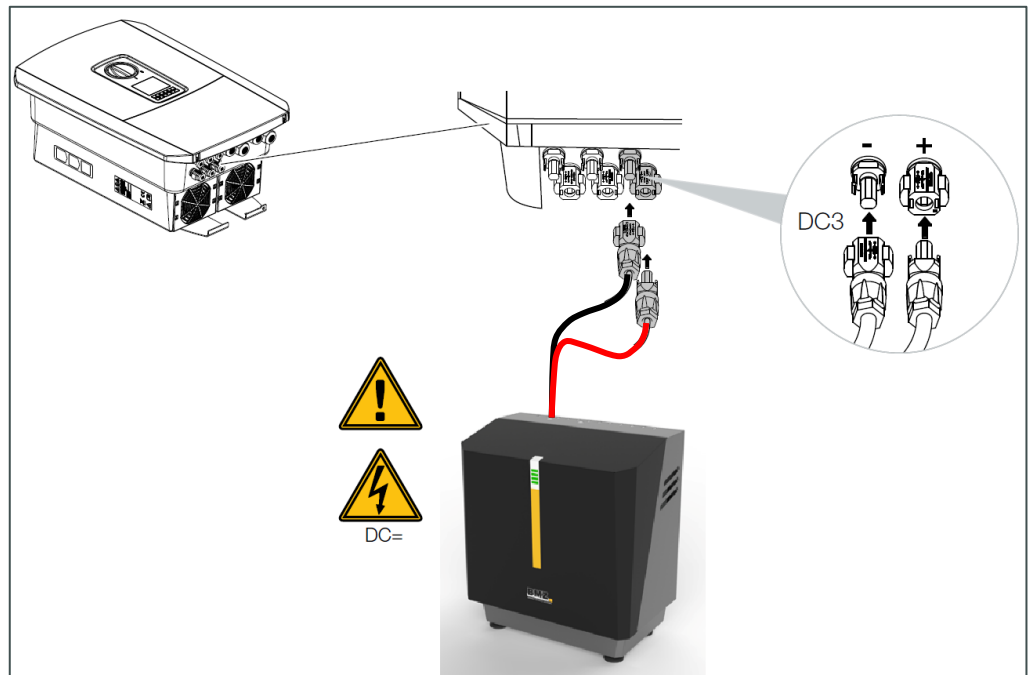

7. Check all electrical connections.

3.4.3 Sungrow SH5.0RT / SH6.0RT / SH8.0RT / SH10RT

Instructions

1. Preparation: Ground the Hyperion housing:

⇒ PE

- yellow-green: Lay out according to normative specifications

Figure 9: Connecting the Sungrow SH RT to the BMZ Hyperion

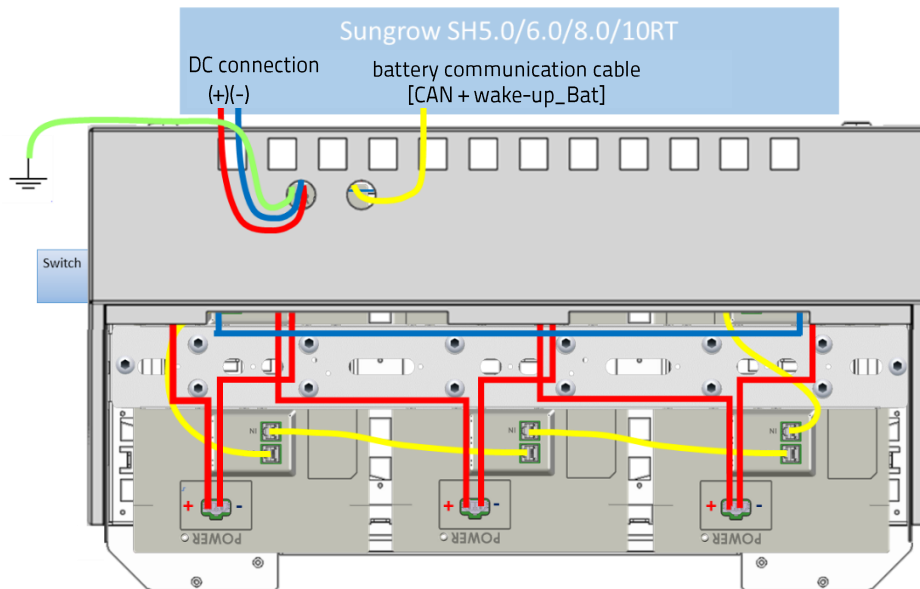

2. Connect DC:

⇒ Attach the Sunlix plug accordingly and plug in:

- red (+) BAT+
- black (-) BAT-

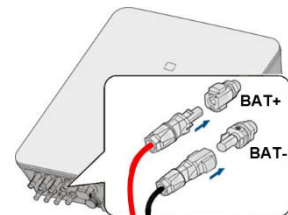

3. Battery communication cable

Lay in COM plug connector:

- yellow: CAN H (H)
- white: CAN L (L)
- orange: Enable (En_H)
- blue: GND (En_G)



DC=

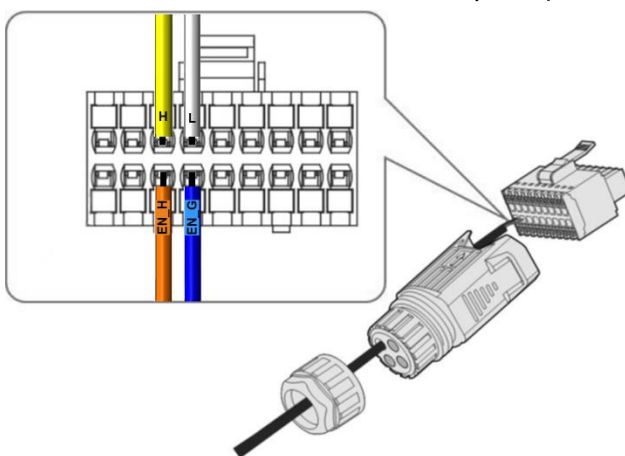

4. Assemble COM connector and plug into the bottom of the inverter.
5. Check all electrical connections.

3.4.4 GoodWe ET PLUS+ GW5K/GW6.5K/GW8K/GW10K

1. Preparation: Ground the Hyperion housing.

⇒ PE

- yellow-green: Lay out according to normative specifications

Figure 10: Connection of the GoodWe ET PLUS+ to the BMZ Hyperion

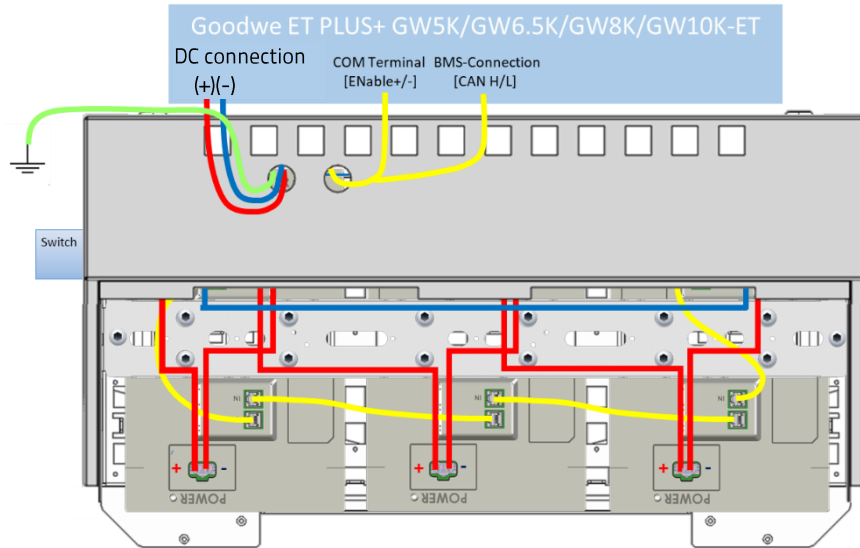

2. Connect DC

⇒ Attach the BAT connector accordingly and plug in:

- red (+) BAT+
- black (-) BAT-

⇒ **NOTICE:** If necessary, adapt the conductor to 6 mm².

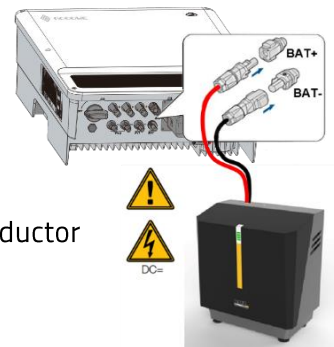

3. Insert the ET PLUS+ BMS battery communication cable into the Hyperion housing and connect it to the BMS master connector X2.:

- Blue Pin 1 CAN H
- Blue-white Pin 2 CAN L

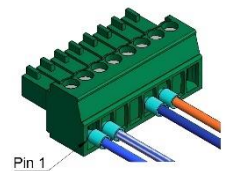

4. Insert the Hyperion communication cable into the ET PLUS+ COM terminal and connect the enable signals:

- Orange Pin 11 Enable (LG_EN+)
- Blue Pin 12 GND (LG_EN-)

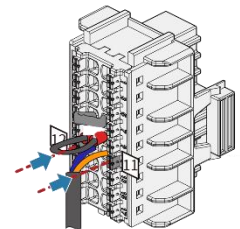

5. When all connection work is complete, assemble the COM terminal and plug it into the bottom of the inverter.

6. Check all electrical connections.

NOTICE: When commissioning with the PV Master app, you must select "Default" as the battery model under Setup.

Instructions

3.5 Putting the Hyperion storage system into operation

1. Commission the inverter.
2. Set up the inverter communication so that the battery system can be set up.
3. Switch the DC disconnecter on the left side of the Hyperion to "on".
4. Commission the storage system according to the operating manual of the connected inverter.

4 Repair

The modular battery may only be opened and repaired by the manufacturer.

Defective modules will be sent to the manufacturer's service department.

5 Decommissioning, storage

5.1 Safety regulations

 **WARNING**

Health hazard due to deep-discharging.

After more than six months of storage, the battery cells can be deeply discharged. This can lead to chemical reactions within the cells, which result in the development of heat and gas, as well as possible health hazards.

- ▶ Recharge the module every six months.

- Switch off the DC switch on the left side of the Hyperion battery system.
- Open the Hyperion.
- Unlock and disconnect both the patch cables and the power cables on the Helios modular batteries.
- Mask the power socket with insulating tape.
- All current legal fire protection requirements must be met. In case of doubt, contact your local fire brigade and your insurance agency.
- Store the modular battery in a dry place, protected from sunlight.
- If the modular battery has been in water or any other liquid, it must not be put back into operation.

5.2 Storage conditions

5.2.1 Storage period

Do not store the module for more than six months from the date of manufacture (see type label). The module must be recharged for longer storage periods.

5.2.2 Physical conditions

Store the module in a dry place, protected from direct sunlight, maximum 3000 m above sea level.

The following conditions should prevail on an average:

■ Temperature:	15 ... 25 °C
Tough limits:	
Storage:	-10 ... 50 °C
Transport:	-20 ... 60 °C
■ Relative humidity:	0 ... 50 %

No more than 4 modular batteries may be stacked on top of each other.

Store modular batteries at least 15 cm above the floor to reduce the risk of water damage.

5.2.3 Cleaning

Before storage, remove dust and other deposits from the battery system. Either by vacuuming and/or with a damp cloth.

6 Packing and transport

The modular battery may only be shipped in suitable packaging that is labelled in accordance with legal requirements and accompanied by the accompanying documents.

If still available and intact, the delivery packaging can be used.

If not, the manufacturer's service department can help you along.

7 Disposal

- Legal requirements** Batteries may not be disposed of in household garbage. As a consumer, you are legally obligated to return used batteries. The return is free of charge.
- Safety** If lithium batteries are not disposed of properly, fire or leakage of hazardous substances may cause damage to health and the environment.
- Return** Please contact the manufacturer when the modular battery has reached the end of its service life.
- Environment** The manufacturer shall send used batteries for recycling in accordance with their electrochemical system. Valuable raw materials are recycled and hazardous substances are disposed of properly. Returning these materials makes a valuable contribution to protecting our environment.

8 Appendix

8.1 BMS master, DC-DC converter and relay in Hyperion

Figure 11: Position of BMS master and DC-DC converter

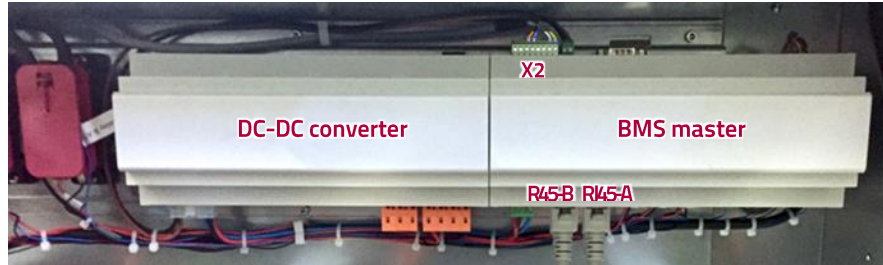

8.2 Assignment BMS master inverter interface (X2)

Table 5: Pin assignment of X2 for SMA SB Storage, Sungrow SH RT and GoodWe ET PLUS+

Hyperion		SMA Sunny Boy Storage 3.7/5.0/6.0		Sungrow SH5.0/6.0/8.0/10RT		GoodWe ET PLUS+ GW5K/GW6.5K/GW8K/GW10K	
Pin	Assignment	Pin	Colour [BATx]	Pin	Colour [COM]	Pin	Colour [Port]
1	CAN H	E	yellow	H	yellow	4	[BMS] blue
2	CAN L	D	white	L	white	5	[BMS] blue/white
3	RS485A	n.c.	n.c.	n.c.	n.c.	n.c.	n.c.
4	RS485B	n.c.	n.c.	n.c.	n.c.	n.c.	n.c.
5	GND	C	blue	EN_G	blue	12	[COM-T.] LG_EN-
6	Enable (12 V, 1 mA)	B	orange	EN_H	orange	11	[COM-T.] LG_EN+
7	Jumper RS485	n.c.	n.c.	n.c.	n.c.	n.c.	n.c.
8	./.	n.c.	n.c.	n.c.	n.c.	n.c.	n.c.

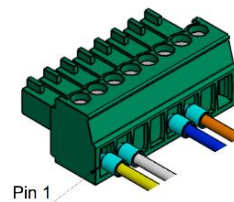

Delivery state

Table 6: Pin assignment of X2 for Kostal PLENTICORE plus/BI

Hyperion		Kostal PLENTICORE plus / PLENTICORE BI	
Pin	Assignment	Pin	Colour [X601]
1	CAN H	n.c.	n.c.
2	CAN L	n.c.	n.c.
3	RS485A	5	yellow
4	RS485B	4	white
5	GND	6	blue
6	Enable (12 V, 1 mA)	1	orange
7	Jumper RS485	n.c.	n.c.
8	./.	n.c.	n.c.

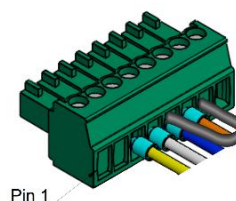

Bridge between pin 5 and 7 defines RS485 and protocol for operation with Kostal PLENTICORE plus / BI

8.3 Adjusting system voltage with SMA SB Storage

To add Helios battery modules, the system voltage must be adjusted to the module voltage. For this purpose set the Sunny Boy Storage to a specific SOC:

1. Open the Sunny Boy Storage user interface.
2. Register as installer.
3. Select **Device Parameters** and click on **Edit Parameters**.
4. Enter the required SOC at **Battery - External Default** and confirm at the top of the Web UI with **Save All**.

Example:

- ⇒ The new battery module has 50.1 V – equals approx. 30 % SOC.
 - ⇒ Hyperion has 60 % SOC – set **Lower battery discharge limit** to 30 % and confirm with **Save all**.
5. The battery system adjusts to the parameterized SOC and holds it.
 6. Install the new battery module. See chapter 3.3.4 from step 3.

Table 7: OCV at SOC Helios battery module and Hyperion system

Voltage	Module	SOC	System voltage with number of battery modules in series			
			3	4	5	6
46.3 V		0 %	138.9 V	185.2 V	231.5 V	277.8 V
47.8 V		10 %	143.5 V	191.3 V	239.1 V	287.0 V
48.8 V		20 %	146.4 V	195.2 V	244.1 V	292.9 V
49.7 V		30 %	149.1 V	198.8 V	248.5 V	298.2 V
50.5 V		40 %	151.5 V	202.0 V	252.5 V	302.9 V
51.5 V		50 %	154.4 V	205.9 V	257.4 V	308.9 V
52.7 V		60 %	158.0 V	210.6 V	263.3 V	315.9 V
53.6 V		70 %	160.9 V	214.6 V	268.2 V	321.9 V
54.8 V		80 %	164.5 V	219.3 V	274.1 V	329.0 V
55.9 V		90 %	167.7 V	223.6 V	279.6 V	335.5 V
56.7 V		100 %	170.1 V	226.8 V	283.5 V	340.2 V

NOTE All voltage specifications refer to the open circuit voltage (OCV).

9 Further directories

9.1 Glossary

Term	Definition
AWG	American Wire Gauge - American standard for wire cross section
BMS	battery management system
CHP	combined heat and power
damage	physical injury or damage to the health of persons, or damage to property or the environment
hazard	potential source of damage
OCV	open current voltage: voltage without load on the battery
PPE	personal protective equipment
qualified personnel	an individual who, on the basis of his or her relevant professional education, training and/or experience, is capable of identifying risks and preventing hazards arising from the use of the product
thermal runaway	chemical process that is triggered by heat and generates additional heat.
user	individual who uses the product

9.2 List of tables

Table 1: Warnings6

Table 2: Explanation of the symbols used.....6

Table 3: Technical data..... 11

Table 4: Overview LED status codes 13

Table 5: Pin assignment of X2 for SMA SB Storage, Sungrow SH RT and GoodWe ET PLUS+ 28

Table 6: Pin assignment of X2 for Kostal PLENTICORE plus/BI 29

Table 7: OCV at SOC Helios battery module and Hyperion system..... 29

9.3 List of figures

Figure 1: Overall view of battery system..... 10

Figure 2: Installation kit..... 11

Figure 3: Insert 3 to 6 Helios modular batteries..... 16

Figure 4: Modular batteries fixed to the grounding support..... 17

Figure 5: Connecting the modules to the BMS master with patch cables..... 17

Figure 6: Power path with switching devices and BMS..... 18

Figure 7: Connecting the SMA SB Storage to the BMZ Hyperion 20

Figure 8: Connecting the PLENTICORE plus / BI to the BMZ Hyperion..... 21

Figure 9: Connecting the Sungrow SH RT to the BMZ Hyperion 23

Figure 10: Connection of the GoodWe ET PLUS+ to the BMZ Hyperion..... 24

Figure 11: Position of BMS master and DC-DC converter..... 28



BMZ Germany GmbH
Zeche Gustav 1
63791 Karlstein am Main
Germany

Tel.: +49 6188 9956-0
Fax: +49 6188 9956-900
E-Mail: mail@bmz-group.com

