

---

## COM100D/COM100E

Smart Communication Box

### Quick Installation Guide

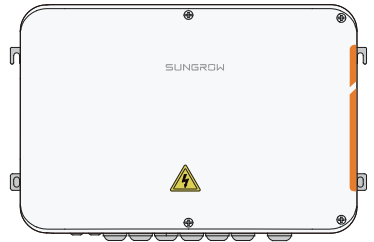

## NOTICE / AVIS / HINWEIS / AVISO

### EN

- Read the COM100D/COM100E User Manual carefully before installation to learn more safety instructions.
- For ease of description, the COM100D/COM100E is referred to as the "COM100" for short hereafter.
- As the content of this document will be periodically updated or revised, the description may be inconsistent with the actual product, and the actual product shall prevail.

### FR

- Veuillez lire attentivement le manuel utilisateur COM100D/COM100E avant toute installation pour en savoir plus sur les consignes de sécurité.
- Pour faciliter la description, le manuel COM100D/COM100E est désigné ci-après "COM100".
- Le contenu de ce document étant périodiquement mis à jour ou révisé, la description peut ne pas être conforme au produit réel ; le produit réel prévaut.

### DE

- Bitte lesen vor der Installation das Benutzerhandbuch zu COM100D/COM100E, um mehr über die Sicherheitsanweisungen zu erfahren.
- Für eine einfachere und kürzere Beschreibung wird COM100D/COM100E im Folgenden als "COM100" bezeichnet.
- Da der Inhalt dieses Dokuments regelmäßig aktualisiert oder überarbeitet wird, kann es sein, dass die Beschreibung nicht mit dem tatsächlichen Produkt übereinstimmt. Das tatsächliche Produkt hat Vorrang.

### PT

- Leia atentamente o Manual do Usuário do COM100D/COM100E antes da instalação para aprender mais instruções de segurança. Produto hat Vorrang.
- Para facilitar a descrição, o COM100D/COM100E é referido como o "COM100" como abreviação daqui em diante.
- Como o conteúdo deste documento será atualizado ou revisado periodicamente, a descrição pode ser inconsistente com o produto real, e o produto real deve prevalecer.

# 1. Typical Application / Application type / Typische Anwendung / Aplicação típica

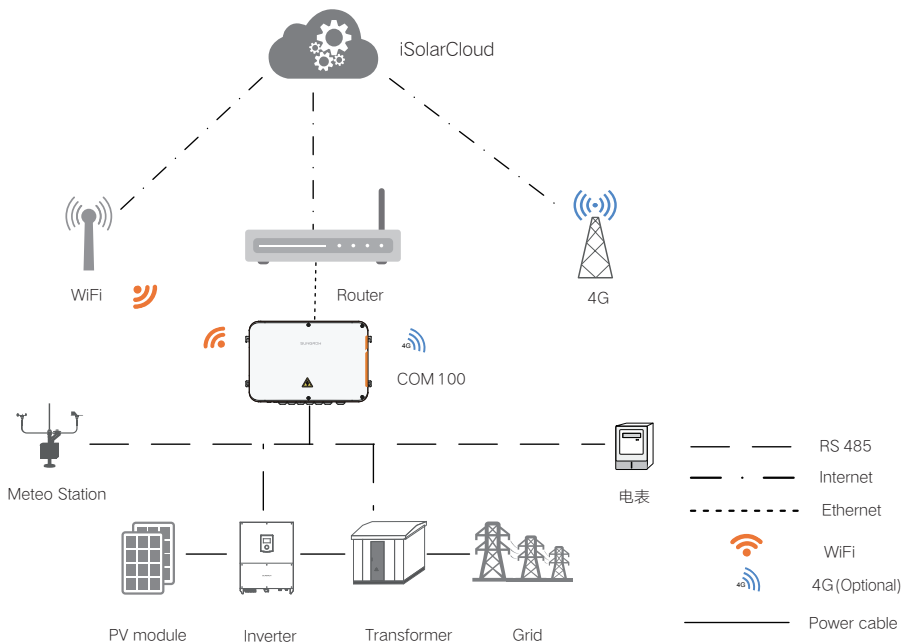

## ⚠ NOTICE

The COM100 can be connected to iSolarCloud via any or a combination of router,WiFi and 4G.

# 2. Mechanical Installation / Installation mécanique / Mechanische Installation / Instalação mecânica

## 2.1 Location Requirement / Exigence liée à l'emplacement / Standortanforderungen / Requisitos de localização

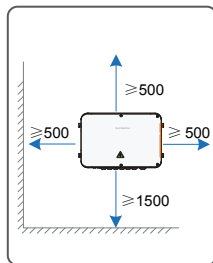
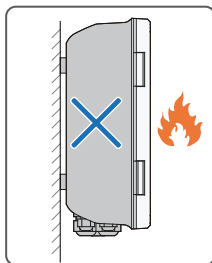
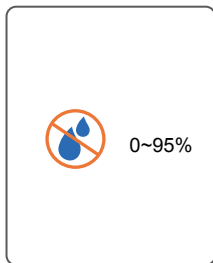
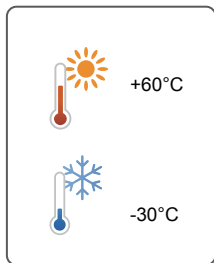

## 2.2 Wall-Mounting / Installation murale / Wandbefestigung / Montado na parede

- Concrete Wall / Mur en béton / Betonwand / Parede de concreto

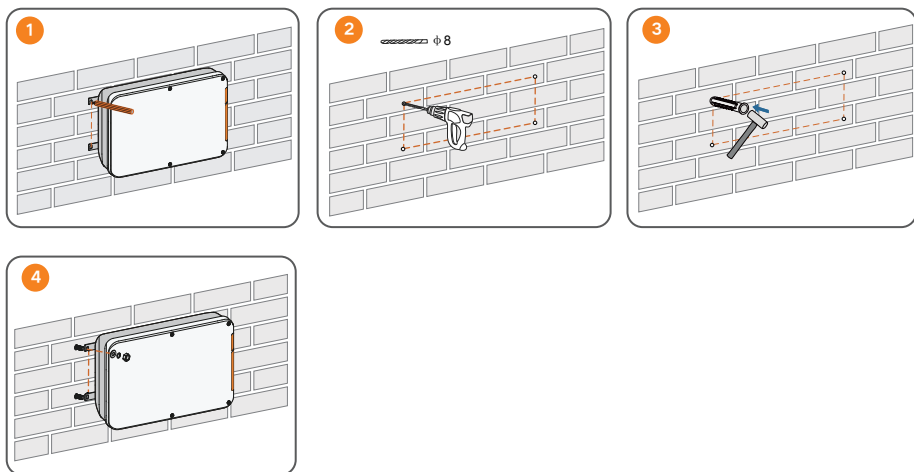

- Metal Surface / Surface en métal / Metaloberfläche / Superfície de metal

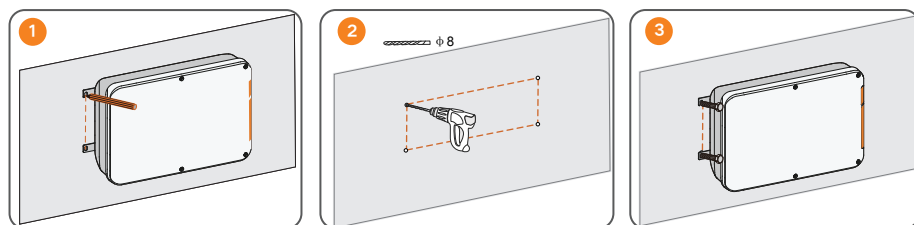

## 2.3 Pole-Mounting (Optional) / Installation sur pôle (facultatif) / Mastmontage (optional) / Montagem em poste (opcional)

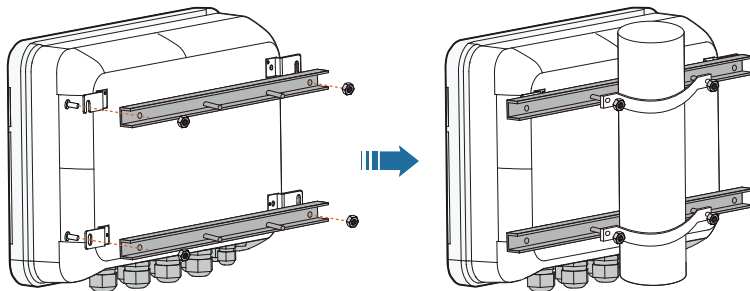

## 2.4 Antenna Installation / Installation de l'antenne / Antenneninstallation / Instalação da antena

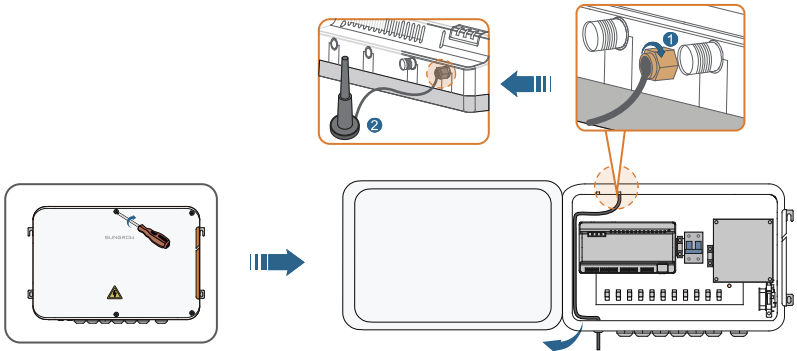
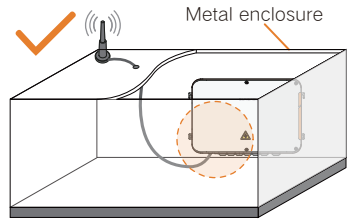
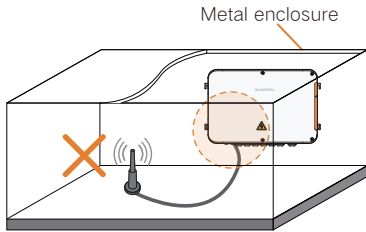

## 3. Electrical Connection / Raccordements électriques / Elektrische Verbindungen / Conexão elétrica

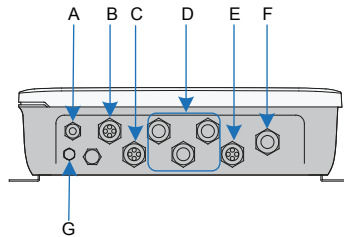

No.	Label	Description
A	RF	Reserved, antenna waterproof terminal
B	AI/DI	AI/DI waterproof terminal
C	DI/DRM	DI/DRM waterproof terminal
D	RS485-1, RS485-2, RS485-3	RS485 waterproof terminal
E	ETH	Ethernet waterproof terminal
F	AC ( 100~277V )	Waterproof terminal for 100Vac to 277Vac power supply
G	-	Waterproof and dustproof ventilation valve

### 3.1 Grounding Connection / Connexion à la terre / Erdungsverbindungen / Conexão de aterramento

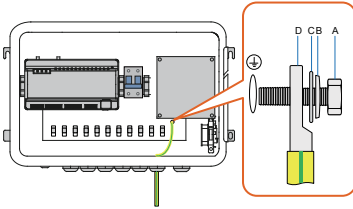

No.	Name
A	Bolt
B	Flat washer
C	Spring washer
D	OT terminal

### 3.2 RS485

- Connect to Device with RS485 Port / Connexion à l'appareil avec un port RS485 / Anschluss an Gerät über RS485-Port / Conectar ao dispositivo com a porta RS485

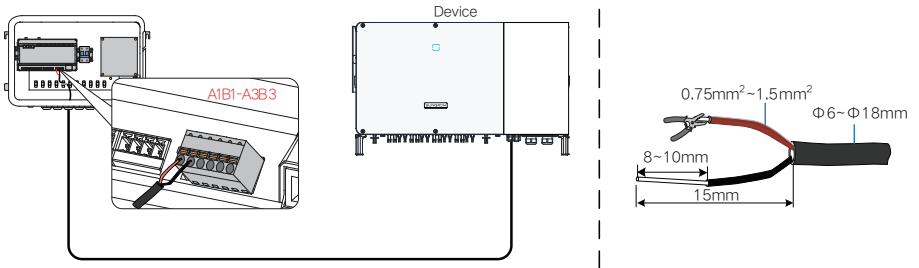

- Connect to Device with RJ45 Port / Connexion à l'appareil avec un port RJ45 / Verbindung mit Gerät über RJ45-Port / Conectar ao dispositivo com a porta RJ45

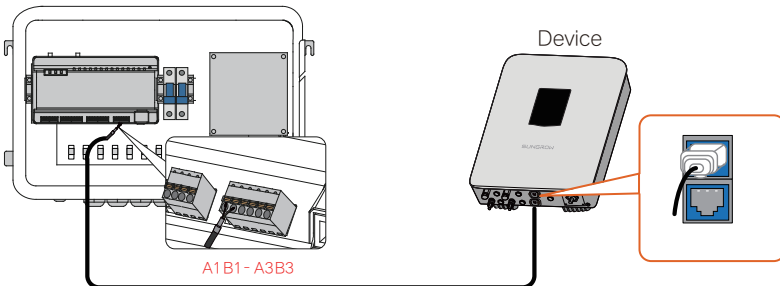
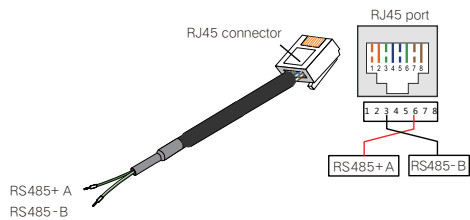

### 3.3 AC Power Supply / Alimentation électrique CA / AC-Netzteil / Fornecimento de energia CA

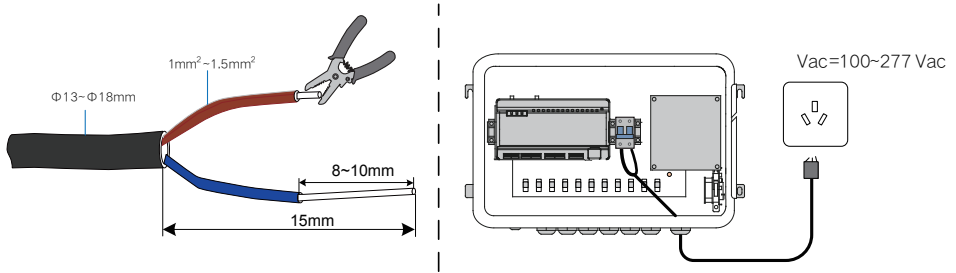

### 3.4 External Electrical Equipment / Équipements électriques externes / Externe Netzgeräte / Equipamento elétrico externo

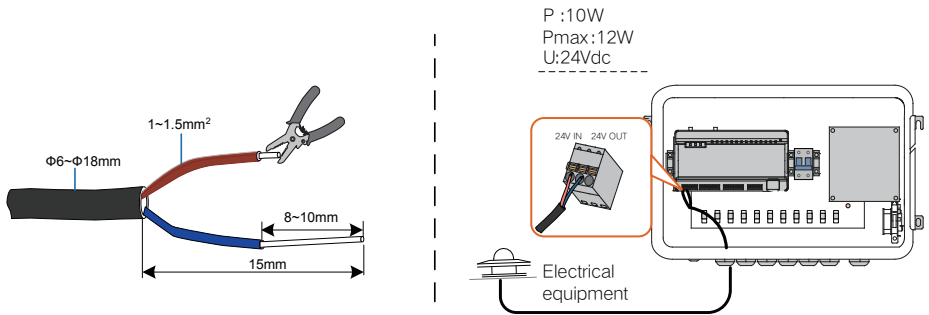

## ⚠ NOTICE / AVIS / HINWEIS / AVISO

### EN

- After finishing cable connection, secure the waterproof terminals and seal the gaps with fireproof mud to prevent moisture penetration and ensure the service life of the COM100.

### FR

- Une fois le branchement du câble terminé, sécurisez les bornes étanches et scellez les espaces avec du joint ignifuge pour empêcher l'humidité de pénétrer et assurer la longévité du COM100.

### DE

- Sichern Sie nach Abschluss der Kabelverbindung die wasserdichten Klemmen und versiegeln Sie die Spalte mit feuerfestem Schlamm, um das Eindringen von Feuchtigkeit zu verhindern und die Lebensdauer von COM100 zu gewährleisten.

### PT

- Depois de terminar a conexão do cabo, fixe os terminais à prova d'água e sele as lacunas com argila à prova de fogo para evitar a penetração de umidade e garantir a vida útil da COM100.

## 4. Commissioning / Mise en service / Inbetriebnahme / Comissionamento

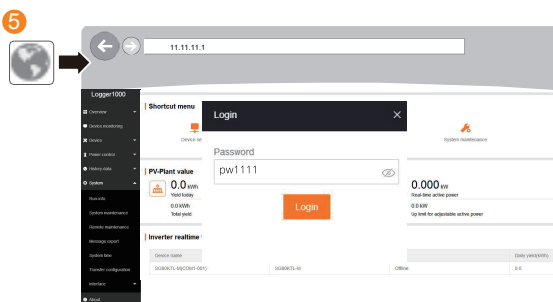
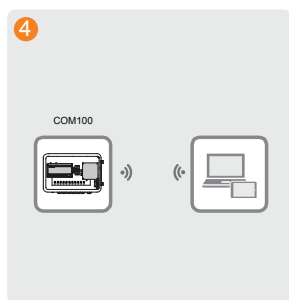
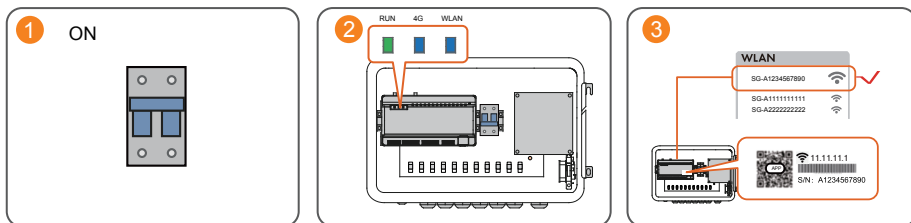

iSolarCloud IEC104 MOCBUS Third-party portal

Server domain	Peer port	Switch	Operation
api.isolarcloud.com	19009	<input checked="" type="checkbox"/>	

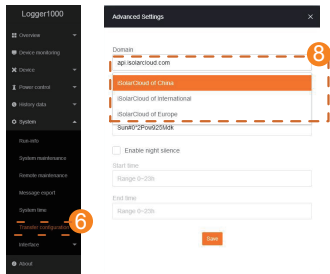

Region	Station
Mainland China	iSolarCloud of China
Europe	iSolarCloud of Europe
Others	iSolarCloud of International

### ⚠ NOTICE / AVIS / HINWEIS / AVISO

**EN**

- After commissioning, close the COM100 cabinet door and secure it with screws.

**FR**

- Apr è s la mise en service, fermez la porte conteneur du COM100 et s é curisez-la avec des vis.

**DE**

- Schließen Sie nach der Inbetriebnahme die Schranktü r von COM100 und befestigen Sie sie mit Schrauben.

**PT**

- Ap ó s o comissionamento, feche a porta do gabinete COM100 e fixe-a com parafusos.



5. Related Documents / Documents connexes / Zugehörige Dokumente /  
Documentos relacionados

QR code

COM100D / COM100E  
User Manual



Website

[http://support.sungrowpower.com/  
web/productList?f=1&pid=1&direct  
oryId=113](http://support.sungrowpower.com/web/productList?f=1&pid=1&directoryId=113)

Logger1000A / Logger1000B  
User Manual



[http://support.sungrowpower.com/  
web/productList?f=3&directoryId=  
307](http://support.sungrowpower.com/web/productList?f=3&directoryId=307)



**Sungrow Power Supply Co., Ltd.**

Add: No. 1699 Xiyou Rd., New & High Technology Industrial Development Zone, 230088, Hefei, P. R. China.  
Web: [www.sungrowpower.com](http://www.sungrowpower.com)  
Tel: +86 551 6532 7834 // 6532 7845  
E-mail: [into@sungrow.cn](mailto:into@sungrow.cn)

107100-H/W

**SUNGROW**

Specifications are subject to changes without advance notice.