



## **Fronius Datamanager Galvo - Symo - Primo - Eco**

EN-US

Operating Instructions

System monitoring





# Contents

<b>General Information</b>	<b>5</b>
General .....	7
General .....	7
Available Versions of Fronius Datamanager.....	7
Applicable DATCOM Components .....	7
Prerequisites for Operation .....	7
Notes regarding Radio Certification .....	8
Scope of Supply.....	9
Configuration Examples.....	9
Calculating the data volume.....	11
General .....	11
Firmware versions for calculating the data volume.....	11
Calculating Data Volumes.....	11
Calculation examples.....	12
General information for the network administrator.....	14
Requirements.....	14
General Firewall Settings.....	14
Sending service messages via a DSL Internet connection.....	15
Using Fronius Solar.web and sending service messages .....	15
Controls, connections and indicators .....	16
Safety.....	16
Controls, Connections, and Indicators .....	16
Schematic Connection of I/Os .....	18
<b>Installing Fronius Datamanager</b>	<b>19</b>
Inserting Fronius Datamanager into an inverter.....	21
General .....	21
Safety.....	21
Installing Fronius Datamanager in Fronius Solar Net .....	22
Installing Inverters with Fronius Datamanager in Fronius Solar Net.....	22
Cabling.....	23
Fronius Solar Net clients.....	23
Fronius Solar Net Client Cabling.....	23
Requirements for the Solar Net Data Cables.....	23
Preassembled data cables.....	24
Installing Fronius Datamanager – Overview .....	25
Safety.....	25
Starting Up for the First Time.....	25
<b>Connect to Fronius Datamanager</b>	<b>27</b>
Connecting to Fronius Datamanager via a Web Browser .....	29
General .....	29
Requirements.....	29
Establishing a Connection to Fronius Datamanager via a Web Browser .....	29
Connecting to Fronius Datamanager via the Internet and Fronius Solar.web .....	30
General .....	30
Function overview .....	30
Requirements .....	30
Accessing data from Fronius Datamanager via the Internet and Fronius Solar.web.....	30
<b>Current Data, Services, and Settings on Fronius Datamanager</b>	<b>31</b>
The Fronius Datamanager Website .....	33
Fronius Datamanager Website – Overview .....	33
The Settings Menu.....	33
Other setting options.....	34

Current Data in Fronius Datamanager .....	35
Current Comparison View .....	35
System Overview .....	36
Inverter/Sensors View .....	36
Services – System Information .....	38
System Information .....	38
Services – Network Diagnostics .....	39
Network Diagnostics .....	39
Services – Firmware Update .....	40
General .....	40
Automatic Update Search .....	40
Manual Update Search .....	41
Firmware update via web .....	41
Firmware Update via LAN .....	42
Services – Opening Wizards .....	44
Opening Wizards .....	44
Settings – General .....	45
General .....	45
Settings – Passwords .....	46
General .....	46
Passwords .....	46
Settings – Inverter .....	48
Views – Inverter .....	48
Settings – Fronius Sensor Cards .....	49
Sensor Cards .....	49
Settings – Fronius Solar.web .....	50
Solar.web .....	50
Calculating memory capacity .....	52
Memory capacity .....	52
Calculating memory capacity .....	52
Calculation example .....	52
Settings – Service Messages .....	54
General .....	54
Service Messages .....	54
Settings – Network .....	56
General .....	56
Network .....	56
Settings – Energy Manager .....	60
General .....	60
Load Management .....	60
Settings – Push Service .....	62
Push Service .....	62
Further Information about the Push Service Function .....	63
Modbus Settings .....	64
General .....	64
Additional Information on the Modbus Function .....	64
Data Output via Modbus .....	64
Limit Control .....	65
Save or Reject Changes .....	66
Settings – Counter .....	67
General .....	67
Counter .....	67
S0 Inverter .....	67
Settings – DNO Editor .....	70
General .....	70
UC Editor – IO Control .....	70
Connection Example .....	71
UC Editor – Dynamic Power Reduction .....	72
UC Editor – Control Priorities .....	73

**Appendix** **75**

Technical Data .....	77
Technical Data .....	77



# **General Information**



# General

---

## General

Fronius Datamanager is a network-compatible datalogger which combines the functionality of the Fronius Com Card and Fronius Datalogger Web on a plug-in card.

The Fronius Datamanager web interface provides a quick overview of the photovoltaic system.

The web interface can be accessed via a direct connection from the Intranet or, if properly configured, via the Internet.

Fronius Datamanager is equipped with an easy-to-configure system monitoring feature with an automatic alarm. The alarm can be signaled via SMS, e-mail, or fax.

When connected to Fronius Solar.access, real-time photovoltaic system data as well as archived data can be saved to a PC and analyzed. You can also make settings to all devices in Fronius Solar Net.

When connected to Fronius Solar.web, the real-time and archived data of a photovoltaic system can be easily accessed via the Internet or the Fronius Solar.web App. No difficult configuration is required. Data is sent automatically from Fronius Datamanager to Fronius Solar.web.

## Available Versions of Fronius Datamanager

The following versions of Fronius Datamanager are available for the Fronius Galvo, Fronius Symo, Fronius Primo, and Fronius Eco inverters:

- Without Fronius Com Card function
- Without Fronius Com Card function and with WLAN

Provided that the inverter is not fitted as standard with Fronius Datamanager, existing inverters can be upgraded with Fronius Datamanager.

## Applicable DAT-COM Components

The Fronius Datamanager plug-in card installed in the inverter can be operated with the following DATCOM components:

- |             |   |   |
|-------------|---|---|
| - up to 100 | x | Fronius inverters<br>(incl. the inverter in which the Fronius Datamanager is installed) |
| - up to 10  | x | Fronius Sensor Card or Fronius Sensor Box   |
| - up to 10  | x | Fronius Public Display Card or Fronius Public Display Box                               |
| - up to 1   | x | Fronius Interface Card or Fronius Interface Box   |
| - up to 200 | x | Fronius String Control  |

## Prerequisites for Operation

In order to ensure flawless data exchange online, it is essential to use an appropriate internet connection:

- For cabled internet solutions, Fronius recommends a download speed of at least 512 kbit/s and an upload speed of at least 256 kbit/s.
- For solutions with mobile internet services, Fronius recommends a minimum transmission standard of 3G with reliable signal strength.

These specifications do not provide an absolute guarantee of flawless operation. High error rates in the transmission, fluctuating receptions or misfires can have an adverse effect on Fronius Datamanager's online operation. Fronius recommends on-site testing to ensure that the connections meet the minimum requirements.

Since Fronius Datamanager acts as a data logger, no other data logger may be present in the Fronius Solar Net ring.  
Only have one Fronius Datamanager for each Fronius Solar Net ring.

The following DATCOM components may not be operated together with the Fronius Datamanager in a Fronius Solar Net ring:

- Fronius Power Control Card/Box
- Fronius Modbus Card
- Fronius Datalogger Web
- Fronius Personal Display DL Box
- Fronius Datalogger easy/pro
- Fronius Datamanager 2.0
- Fronius Datamanager Box 2.0

To use Fronius Datamanager, the plug-in card must be installed in one inverter. The Fronius Datamanager plug-in card and the Fronius Com Card must not be used together in one inverter.

---

## Notes regarding Radio Certification

Fronius Datamanager plug-in cards with WLAN are equipped with a wireless module.

Wireless modules in the USA require FCC certification:



### FCC

This device conforms to the limits for a Class B digital device, pursuant to Part 15 of the FCC regulations. These limits are designed to provide reasonable protection against harmful interference in a residential installation. This device generates and uses high frequency energy and, if not used in accordance with the instructions, may interfere with radio communications. However, there is no guarantee that interference will not occur in a particular installation.

If this device does cause harmful interference to radio or television reception, which can be determined by turning the device off and on, the user is encouraged to try to correct the interference by one or more of the following measures:

- Reorient or relocate the receiving antenna.
- Increase the distance between the device and the receiver.
- Connect the device to a different circuit than the receiver.
- Consult the dealer or an experienced radio/TV technician for help.

FCC ID: PV7-WIBEAR11N-DF1

### Industry Canada RSS

This device complies with Industry Canada license-exempt RSS standards. Operation is subject to the following two conditions:

- (1) this device is not permitted to cause harmful interference, and
- (2) this device must accept any interference, including interference that may cause undesired operation of the device.

IC ID: 7738A-WB11NDF1

Unless otherwise expressly permitted by the manufacturer, changes or modifications to the wireless module are not allowed and lead to a loss of the right of use of the device by the user.

### Scope of Supply

Basic equipment:

- 1 x Fronius Datamanager plug-in card
- 1 x Ethernet cable 5 m, blue
- 2 x Terminating plugs
- 1 x 12-pin plug

In addition for Fronius Datamanager with WLAN:

- 1 x WLAN antenna

### Configuration Examples

Linking inverters with 'Fronius Datamanager' to a PC:

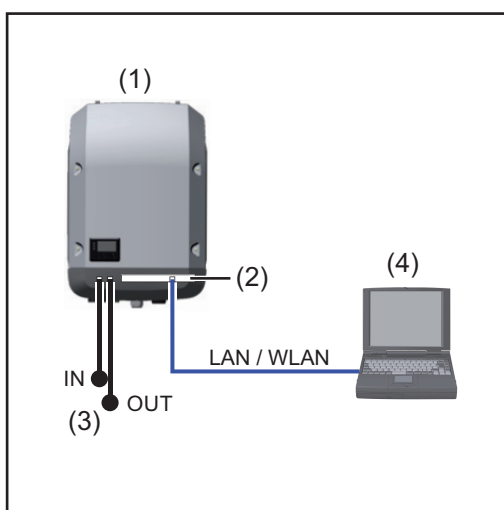

- (1) Inverter  
+
- (2) Fronius Datamanager
- (3) Terminating plug (2x)
- (4) PC/laptop

When linking an inverter with 'Fronius Datamanager' to a PC, a terminating plug must be inserted into both of the Fronius Solar Net IN and Fronius Solar Net OUT connection sockets of the inverter.

**Linking inverters (Fronius Galvo, Fronius Symo, Fronius Primo, and Fronius Eco) with 'Fronius Datamanager' to additional inverters (Fronius IG Plus V), a 'Fronius Sensor Box' and a PC:**

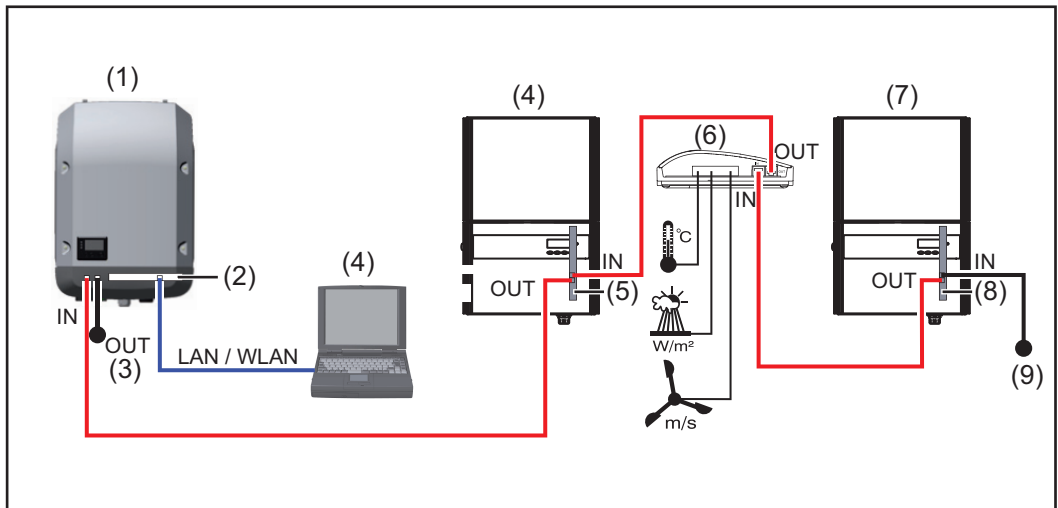

- |     |  |     |  |
|-----|--|-----|--|
| (1) | Inverter<br>(e.g: Fronius Galvo, Fronius Sy-<br>mo, Fronius Primo, or Fronius<br>Eco)<br>+ | (6) | Fronius Sensor Box                         |
| (2) | Fronius Datamanager  | (7) | Inverter<br>(e.g., Fronius IG Plus V)<br>+ |
| (3) | PC/laptop  | (8) | Fronius Com Card                           |
| (4) | Inverter<br>(e.g., Fronius IG Plus V)<br>+   | (9) | Terminating plug                           |
| (5) | Fronius Com Card   |     |  |

When networking several DATCOM components in conjunction with an inverter with 'Fronius Datamanager':

Using the data cable, connect, for example, the Fronius Solar Net IN connection socket of the inverter and the OUT connection socket of the next DATCOM component. A terminating plug must be inserted into empty Fronius Solar Net connection sockets of the last DATCOM component.

# Calculating the data volume

## General

When operating the Fronius Datamanager, data is generated and needs to be transmitted online.

In order to select a suitable internet connection it is necessary to calculate the data volume.

The following data volume calculation provides an overview of the amount of data generated when operating Fronius Datamanager.

## Firmware versions for calculating the data volume

The data volume calculation is based on Fronius Datamanager Firmware versions V 2.3.x-x and lower.

Higher firmware versions can cause a higher data volume due to their increased functional range.

## Calculating Data Volumes

The data volume calculation depends on which Fronius Datamanager functions are activated.

Function	Data volume	
Make real-time data available in Fronius Solar.web	Once <sup>1)</sup>	150 bytes 32 KB/h
View real-time data in Fronius Solar.web	Current Total View per sensor card/sensor box	42 KB/h + 300 KB/h
	Current Comparison View per inverter	13 KB/h + 4 KB/h
	Home	0 KB/h
	System Comparison View	0 KB/h
Send archived data/logging data to Fronius Solar.web	(Memory sectors per day <sup>2)</sup> x 4 KB) + 8 KB	
	Transmission time <sup>3)</sup>	600 bytes/min
Send service messages or errors	For daily sending per service message or error	1 KB/day + 300 bytes
	For immediate sending per service message or error	1 KB

1) Only after a restart or if the internet connection has been disconnected

2) Calculation of memory sectors per day according to Chapter "Calculating Memory Capacity" on page 52

3) Depending on the quality of the internet connection

**IMPORTANT:** Since the values listed in the table are "rough data" for Fronius Datamanager and the provider's bill may show discrepancies as a result of the various ways of calculating the transfer volume, the total values should be increased by 10–20%.

If the functions have been deactivated, no data volume is generated.

A certain data volume is also required to update the Fronius Datamanager firmware. This data volume depends on the size of the relevant update package and cannot therefore be taken into account for any advance calculation of the data volume.

**IMPORTANT:** Fronius recommends a flat rate in order to avoid unforeseeable data volumes.

**Calculation examples**

**Example 1 - Home System**

1 inverter;	+ 0.15 KB
No Fronius Sensor Card/Box;	
Fronius Datamanager has a 24-hour internet connection;	+ 32 KB/h x 24 h = 768 KB
Archived data is sent to Fronius Solar.web;	
30 minutes transfer time;	+ 0.6 KB/min x 30 min = 18 KB
inverters operate 14 h/day;	
15 minutes storage interval;	+ (1 memory sector/day x 4 KB) + 8 KB = 12 KB
(This results in 1 memory sector per day in accordance with the section "Calculating memory capacity")	
Real-time data is viewed over a 15-minute period every day	+ 42 KB/h x 0.25 h = 10.5 KB
1 service message sent each day to confirm average error rate	+ 1 service message x 1 KB = 1 KB
Subtotal without safety	0.15 KB 768.00 KB 18.00 KB 12.00 KB 10.50 KB 1.00 KB
	<hr/> 809.65 KB
A 10% safety factor is added to the calculation	809.65 KB + 10%
<b>Final result</b>	<b>890.615 KB/day</b>

**Example 2 - Large System**

100 inverters;	+ 0.15 KB
10 sensor cards/sensor boxes;	
Fronius Datamanager has a 24-hour internet connection;	+ 32 KB/h x 24 h = 768 KB
Archived data is sent to Fronius Solar.web;	
120 minutes transfer time;	+ 0.6 KB/min x 120 min = 72 KB
inverters operate 14 h/day;	
5 minutes storage interval;	+ (173 memory sectors/day x 4 KB) + 8 KB = 700 KB
(This results in 173 memory sectors per day in accordance with the section "Calculating memory capacity")	



The current Total View and the current Comparison View are viewed over a two-hour period every day

+ 42 KB/h x 2 h  
 + 300 KB/h x 10 x 2 h  
 + (13 KB/h + 100 x 4 KB/h) x 2 h  
 = 6910 KB

50 service messages sent each day to confirm average error rate

+ 50 service messages x 1 KB = 50 KB

Subtotal without safety

0.15 KB  
 768.00 KB  
 72.00 KB  
 700.00 KB  
 6910.00 KB  
 50.00 KB  

---

 8,500.15 KB

A 10% safety factor is added to the calculation

8,500.15 KB + 10%

**Final result** 9,350.165 KB/day  
(approx. 9.35 MB/day)

# General information for the network administrator

---

## Requirements

Configuring a network for 'Fronius Datamanager' requires knowledge of network technology.

If 'Fronius Datamanager' is being integrated into an existing network, the 'Fronius Datamanager' address must be adapted to the network.

Example: Network address range = 192.168.1.x, subnet mask = 255.255.255.0

- An IP address between 192.168.1.1 and 192.168.1.254 must be assigned to 'Fronius Datamanager'.
- The IP address selected may not be already assigned in the network.
- The subnet mask must correspond to the existing network (e.g., 255.255.255.0).

If 'Fronius Datamanager' will be sending service messages and/or data to 'Fronius Solar.web', then a gateway address and a DNS server address must also be entered. 'Fronius Datamanager' uses the gateway address to access the Internet. The IP address of the DSL router can be used as a gateway address, for example.

### IMPORTANT!

- 'Fronius Datamanager' may not have the same IP address as the PC/laptop!
- 'Fronius Datamanager' cannot connect to the internet by itself. A router must be used for a DSL connection to the internet.

If you are using the WLAN network connection, the 'Fronius Datamanager' must be equipped with a WLAN function and a WLAN antenna suitable for the inverter.

---

## General Firewall Settings

DSL routers mostly enable you to send data to the internet and, therefore, do not normally have to be configured.

If existing firewall rules block the connection to the Fronius system monitoring, the following firewall rules must be added:

	49049/UDP output	80/TCP *) input
Sending service messages	x	-
Connecting to Datamanager via Fronius Solar.web	x	-
Connecting to Datamanager via Fronius Solar.access or Fronius Solar.Service	-	x
Accessing the Datamanager website	-	x

Configure the firewall so that the IP address of Fronius system monitoring can send data to port 49049/UDP from "fdmp.solarweb.com".

\*) We recommend only allowing access to the web interface of the Fronius system monitoring from a secure network. If access via the internet is absolutely necessary (e.g. for service purposes during a limited time period), configure the network router so that requests for any external port are redirected to port 80/TCP.

Caution - this will make the inverter visible on the internet and more likely to be subject to network attacks.

---

**Sending service messages via a DSL Internet connection**

Normally, no additional router configuration is required for a regular DSL Internet connection for accessing 'Fronius Solar.web' and/or sending service messages, because connections from the LAN to the Internet are open.

---

**Using Fronius Solar.web and sending service messages**

However, an internet connection is required to use Fronius Solar.web and send service messages.

Fronius Datamanager cannot connect to the Internet spontaneously. A router must be used for a DSL connection to the Internet.

# Controls, connections and indicators

## Safety



### WARNING!

**Operating the device incorrectly can cause serious injury and damage.**

Do not use the functions described until you

- ▶ have completely read and understood these Operating Instructions,
- ▶ have completely read and understood all system component Operating Instructions, especially the safety rules.

## Controls, Connections, and Indicators

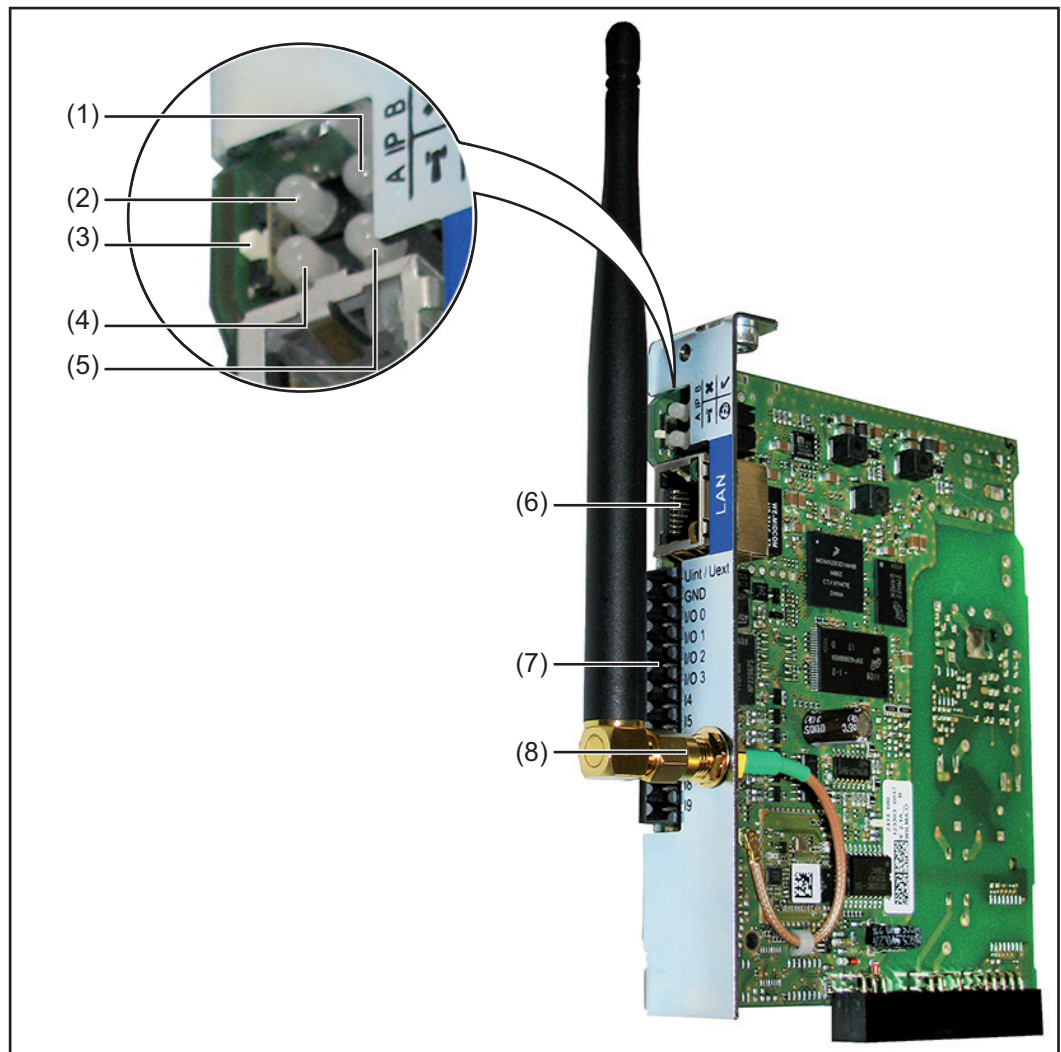

No.	Function	
(1)	<b>Supply LED</b>	✓
	<ul style="list-style-type: none"> <li>- Lights up green: Sufficient power is coming from 'Fronius Solar Net'; 'Fronius Datamanager' is operational</li> <li>- Does not light up: No power or not enough power is coming from 'Fronius Solar Net'; an external power supply is required</li> <li>- Flashes red: During an update process</li> </ul> <p style="text-align: center;"><b>IMPORTANT!</b> Do not interrupt the power supply during an update process.</p> <ul style="list-style-type: none"> <li>- Lights up red: Update process failed</li> </ul>	
(2)	<b>Connection LED</b>	✗
	<ul style="list-style-type: none"> <li>- Lights up green: There is an active connection within 'Fronius Solar Net'</li> <li>- Lights up red: There is an interrupted connection within 'Fronius Solar Net'</li> </ul>	
(3)	<b>IP Switch</b>	
	For changing the IP address:	
	A Default IP address "169.254.0.180" 'Fronius Datamanager' uses the fixed IP address 169.254.0.180; the fixed IP address is used to establish a direct connection to a PC via LAN without having to configure the PC first	
	B Assigned IP address 'Fronius Datamanager' operates using an assigned IP address (factory setting 192.168.1.180); The IP address can be set on the 'Fronius Datamanager' web interface.	
(4)	<b>WLAN LED</b>	†
	<ul style="list-style-type: none"> <li>- Flashes green: Fronius Datamanager is in service mode (IP switch on the Fronius Datamanager plug-in card is in position A)</li> <li>- Lights up green: There is an existing network connection</li> <li>- Lights up red: There is no existing network connection</li> <li>- Does not light up: Plug-in card without WLAN</li> </ul>	
(5)	<b>Solar Web LED connection</b>	🌐
	<ul style="list-style-type: none"> <li>- Lights up green: There is an existing connection to 'Fronius Solar.web'</li> <li>- Lights up red: There is no connection to 'Fronius Solar.web', but one is required</li> <li>- Does not light up: No connection to 'Fronius Solar.web' is required</li> </ul>	
(6)	<b>LAN Connection</b>	
	Blue Ethernet interface, used to connect the Ethernet cable	
(7)	<b>I/Os</b>	
	Digital inputs and outputs	
	<b>Digital inputs:</b> I/O 0 – I/O 3, I 4 – I 9 voltage level: low = min. 0 V – max. 1.8 V; high = min. 3 V – max. 30 V input currents: dependent on input voltage; input resistance = 46 kOhm	
	<b>Digital outputs:</b> I/O 0 – I/O 3 Switching capacity when supplied by the Datamanager plug-in card: 3.2 W, 10.7 V in total for all 4 digital outputs	
	Switching capacity when supplied by an external power supply with min. 10.7 – max. 24 V DC, connected to Uint/Uext and GND: 1 A, 10.7 - 24 V DC (depending on the external power supply) per digital output	
	The connection to the I/Os is made via the supplied mating connector.	
(8)	<b>WLAN Antenna Socket with WLAN antenna</b> (only for versions with WLAN) for connecting the WLAN antenna	

**Schematic Connection of I/Os**

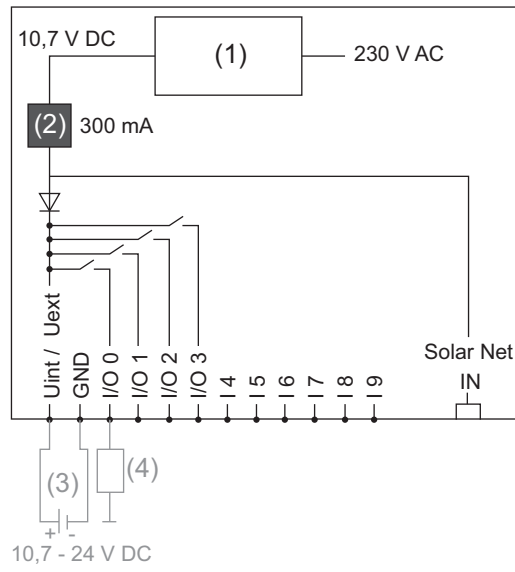

Supply via Datamanager plug-in card:

- (1) Power supply
- (2) Current limit

Supply via external power supply:

- (3) External power supply
- (4) Load

When the supply is via an external power supply, the external power supply must be galvanically isolated.

# **Installing Fronius Datamanager**





# Inserting Fronius Datamanager into an inverter

## General

Provided the Fronius Datamanager plug-in card is not fitted as standard in the inverter, the plug-in card must be inserted into the inverter in accordance with the operating or installation instructions of the inverter in question. Please note the safety and warning information in your inverter's operating instructions.

**IMPORTANT!** Before inserting the Fronius Datamanager plug-in card, remove any existing Fronius Power Control Card, or Fronius Modbus Card!

## Safety



### WARNING!

#### **Danger from grid voltage and DC voltage from solar modules.**

An electric shock can be fatal.

- ▶ The connection area should only be opened by an authorized electrician.
- ▶ The separate power stage set area should only be disconnected from the connection area after first being disconnected from the grid power.
- ▶ The separate power stage set area should only be opened by Fronius-trained service personnel.
- ▶ Before making any connections, make sure that the AC and DC sides in front of the inverter are not charged, e.g.:
- ▶ Switch off the AC automatic circuit breaker for the inverter
- ▶ Cover solar modules
- ▶ Please observe the 5 safety rules.



### WARNING!

#### **Danger of residual voltage from capacitors.**

An electric shock can be fatal.

- ▶ Wait until the capacitors have discharged.

Follow general ESD guidelines when handling plug-in cards.

# Installing Fronius Datamanager in Fronius Solar Net

## Installing Inverters with Fronius Datamanager in Fronius Solar Net

### CAUTION!

DATCOM components and/or the PC/laptop may be seriously damaged if the Ethernet or Solar Net cables are connected incorrectly to the Fronius Datamanager.

- ▶ The Ethernet cable should only be inserted into the LAN connection socket (colored blue).
- ▶ The Solar Net cable should only be inserted into the inverter Solar Net IN or Solar Net OUT connection sockets.

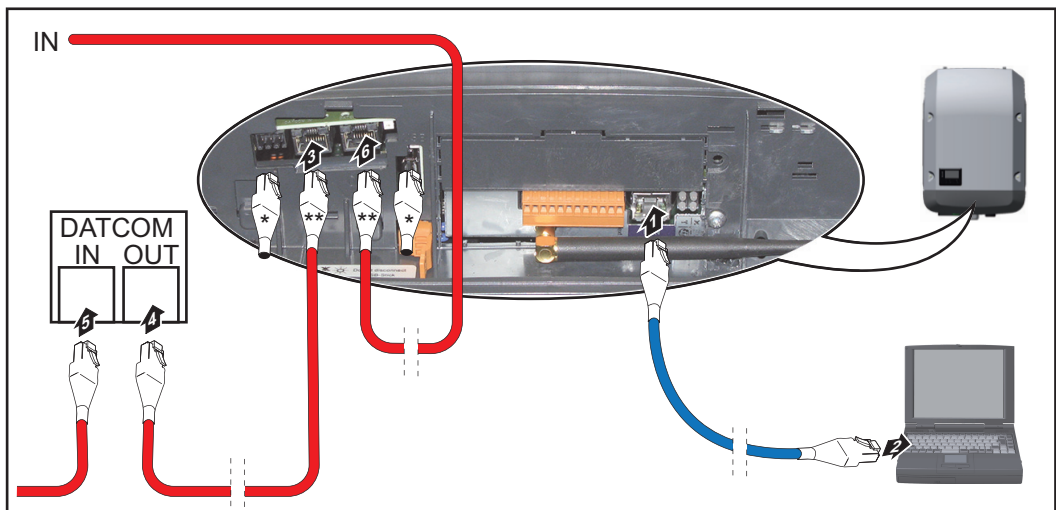

- \* Terminating plug, if only one inverter with Fronius Datamanager is linked to a PC or if there is no further Solar Net subscriber on the Solar Net connection socket.
- \*\* Solar Net Cable, if an inverter with Fronius Datamanager is linked to a PC and other DATCOM components

- 1 Insert and lay the Ethernet cable in the inverter like a data communication cable in accordance with the operating instructions for the inverter.
- 2 Insert the Ethernet cable into the LAN connection socket.
- 3 Insert the Ethernet cable into the PC/laptop or into a suitable network connection socket.
- 4 If only one inverter with Fronius Datamanager is being linked to a PC: Insert a terminating plug into the Solar Net IN connection socket and the Solar Net OUT connection socket

If other DATCOM components are connected to the network, besides the inverter with Fronius Datamanager:  
Insert the Solar Net cable into the Solar Net IN connection socket and the Solar Net OUT connection socket.

- 5 Connect the other DATCOM components.

**IMPORTANT!** A terminating plug must be inserted into every empty Solar Net connection socket of the last DATACOM component.

# Cabling

## Fronius Solar Net clients

Inverters with Fronius Datamanager, Fronius Hybridmanager or Fronius Com Card, DAT-COM components with external housing or other DATCOM components will hereinafter be referred to as Fronius Solar Net clients.

## Fronius Solar Net Client Cabling

The data connection for the Fronius Solar Net client is a 1:1 connection using 8-pin data cables and RJ-45 plugs.  
The overall line length in a Fronius Solar Net ring must not exceed 1000 m.

## Requirements for the Solar Net Data Cables

Shielded CAT5 (new) and CAT5e (old) cables compliant with ISO 11801 and EN 50173 must be used for the Fronius Solar Net client cabling. Other cables are not permitted.



**IMPORTANT!** Do not use ISO/IEC-11801 U/UTP cables!

Permitted cables:

- S/STP
- F/STP
- S/FTP
- F/FTP
- SF/FTP
- S/UTP
- F/UTP
- U/FTP
- U/STP

The shield must be crimped onto a CAT5-compatible shielded plug.

Due to the fact that the wires in Ethernet cables are twisted, you must make sure the twisted pairs of wires are assigned correctly for cabling in accordance with TIA/EIA-568B:

Fronius Solar Net contact	Pair no.	Color
1 +12 V	3	 white/orange line
2 GND	3	 orange/white line or orange
3 TX+ IN, RX+ OUT	2	 white/green line
4 RX+ IN, TX+ OUT	1	 blue/white line or blue
5 RX- IN, TX- OUT	1	 white/blue line
6 TX- IN, RX- OUT	2	 green/white line or green
7 GND	4	 white/brown line
8 +12 V	4	 brown/white line or brown

*Cabling compliant with TIA/EIA-568B*

- Make sure that the wires are assigned correctly.
- When setting up an independent ground connection (e.g., in patch panels), make sure that the shield is grounded on one side of the cable only.

The following structured cabling standards must generally be observed:

- EN 50173-1 for Europe
- ISO/IEC 11801:2002 internationally
- TIA/EIA 568 for North America

Rules for use of copper cables apply.

---

**Preassembled  
data cables**

The following preassembled data cables are available from Fronius:

- CAT5 cable 1 m ... 43,0004,2435
- CAT5 cable 20 m ... 43,0004,2434
- CAT5 cable 60 m ... 43,0004,2436

The cables listed above are 8-pin, 1:1 LAN network cables, shielded and twisted, including RJ 45 plugs.

**IMPORTANT!** Data cables are not UV resistant. They should be protected from sunlight when laid outdoors.

# Installing Fronius Datamanager – Overview

## Safety

 **WARNING!**

**Operating the device incorrectly can cause serious injury and damage.**

Do not use the functions described until you

- ▶ have completely read and understood these Operating Instructions,
- ▶ have completely read and understood all system component Operating Instructions, especially the safety rules.

Installing 'Fronius Datamanager' requires knowledge of network technology.

## Starting Up for the First Time

- 1 Insert Fronius Datamanager into the inverter

 See section "Inserting Fronius Datamanager into an inverter"

- 2 Insert blue Ethernet cable into Fronius Datamanager (LAN connection socket)
- 3 Insert terminating plug into Fronius Datamanager (Solar Net IN connection socket)
- 4 Insert blue Ethernet cable into the PC/laptop

 See section "Installing Fronius Datamanager in Fronius Solar Net"

- 5 Turn off WLAN on PC/laptop (to avoid network conflicts)
- 6 Adjust network settings for Fronius Datamanager on PC/laptop: "Obtain an IP address automatically (DHCP)" must be activated
- 7 Switch IP switch on Fronius Datamanager to position - A -

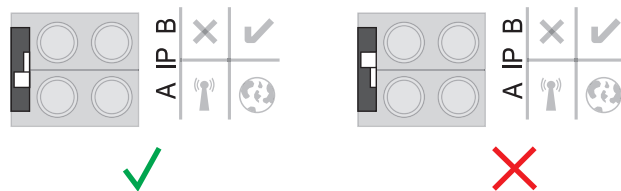

- 8 Close the inverter and switch it on
- 9 After about 1 minute, open the browser on the PC/laptop and enter the following address (web server works with Internet Explorer 9 or higher, Chrome or Firefox):  
http://169.254.0.180

The start page of the Commissioning Wizard appears.

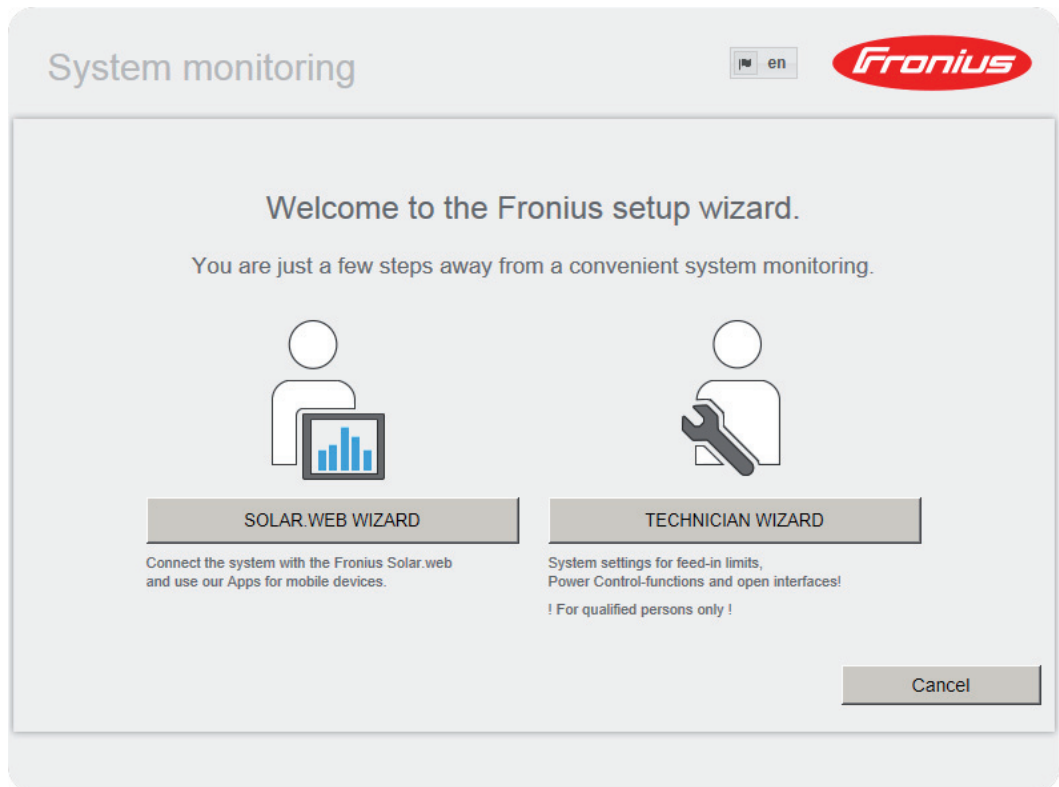

The Technician Wizard is designed for the installer and includes standard-specific settings. If the Technician Wizard is run, it is essential to note down the assigned service password. This service password is required to configure the UC Editor and Counter menu items. If the Technician Wizard is not run, no specifications for power reduction are set.

The Solar Web Wizard must be run.

**6** If necessary, run the Technician Wizard and follow the instructions

**7** Run the Solar Web Wizard and follow the instructions

The Fronius Solar.web start page appears

or

The Fronius Datamanager website opens.

**IMPORTANT:** To establish a connection to Fronius Datamanager, the end device in question (e.g., laptop, tablet) must be configured as follows:

- "Obtain an IP address automatically (DHCP)" must be activated

# **Connect to Fronius Datamanager**





# Connecting to Fronius Datamanager via a Web Browser

## General

The connection to Fronius Datamanager via an internet browser is suitable for accessing current values with several PC users in a LAN (e.g., company networks, schools, etc.).

For example, total and daily yields can be accessed and/or inverter comparisons can be made on the Fronius Datamanager website.

## Requirements

- At least a LAN or WLAN connection
- Web browser (e.g., Microsoft Internet Explorer IE  $\geq$  9.0, Firefox 4, Google Chrome 27.0)
- PC/laptop in the same network segment as Fronius Datamanager

## Establishing a Connection to Fronius Datamanager via a Web Browser

- 1 Open the web browser
- 2 Enter the IP address or the host name and the domain name for Fronius Datamanager in the address field

The Fronius Datamanager web page appears.

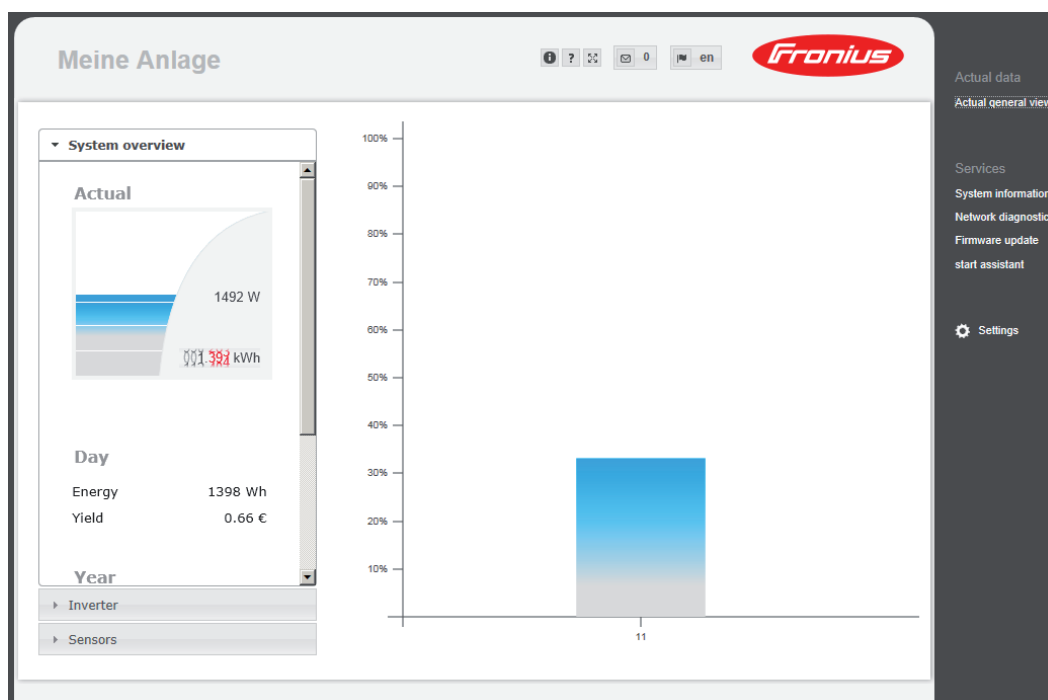

# Connecting to Fronius Datamanager via the Internet and Fronius Solar.web

---

## General

By connecting to Fronius Datamanager via the Internet and Fronius Solar.web, you can access archived data and real-time photovoltaic system data online from anywhere in the world.

You can also provide other users with guest access so that they can view your photovoltaic system, or you can make a comparison of several systems.

---

## Function overview

Fronius Datamanager is connected to the Internet (e.g. via a DSL router). Fronius Datamanager regularly logs on to Fronius Solar.web and sends its saved data every day. Fronius Solar.web can actively contact Fronius Datamanager, e.g. to display real-time data.

---

## Requirements

- Internet access
- Web browser

**IMPORTANT!** Fronius Datamanager cannot connect itself to the Internet. A router must be used for a DSL connection to the Internet.

- Registration of photovoltaic system with Fronius Solar.web.
  - In order to access real-time data in Fronius Solar.web, the "Yes" option must be activated under "Send real-time data to Solar.web" in Fronius Datamanager.
  - In order to access archived data in Fronius Solar.web, the "Daily" or "Hourly" option must be activated under "Send archived data to Solar.web" in Fronius Datamanager.
- 

## Accessing data from Fronius Datamanager via the Internet and Fronius Solar.web

To access real-time and archived data from Fronius Datamanager using Fronius Solar.web:

- 1 Start Fronius Solar.web: <http://www.solarweb.com>  
For more information about Fronius Solar.web, see the online help.

# **Current Data, Services, and Settings on Fronius Datamanager**



# The Fronius Datamanager Website

## Fronius Datamanager Website – Overview

The following data is displayed on the Fronius Datamanager website:

- (1) Current comparison view of all inverters in the Fronius Solar Net ring
- (2) System overview: Current/Day/Year/Total
- (3) Inverter
- (4) Sensors
- (5) Services  
System information, Network diagnostics, Firmware update
- (6) The Settings Menu
- (7) Other Setting Options

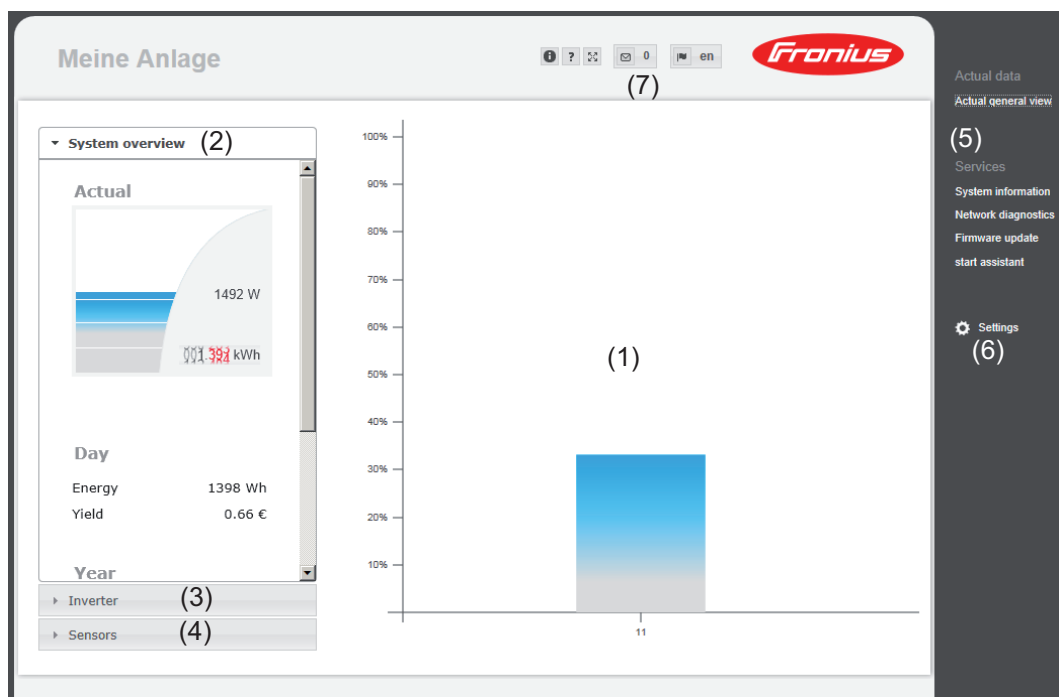

## The Settings Menu

After clicking on "Settings," the Settings menu is opened on the Fronius Datamanager web page. Fronius Datamanager is configured in the Settings menu.



Menu items in Settings menu

### General Adjustment and Viewing of Menu Items

- 1 Connect to Fronius Datamanager
- 2 Click on "Settings"
- 3 Click on the desired menu item
- 4 View menu item or edit accordingly.
- 5 If there is one, click on the relevant button (e.g. Save, Synchronize)

The desired menu item is opened.





The amended data is accepted.

- \* Selected menu item
- \*\* The Counter and UC Editor menu items are protected by the service password.

### Other setting options

Other settings options are shown in the top right corner of the Fronius Datamanager web interface:



-  Display notifications
-  System information:  
Datalogger ID, software version, hardware version, Solar Net connection, Solar.web connection
-  Help:  
Fronius Datamanager operating instructions, available in both English and German
-  Language:  
For setting the language (English or German)  
  
The Fronius Datamanager web interface will appear in the language set in the browser or in the last language selected.
-  Expand contents:  
The Real-time Data/Settings menu is hidden

# Current Data in Fronius Datamanager

## Current Comparison View

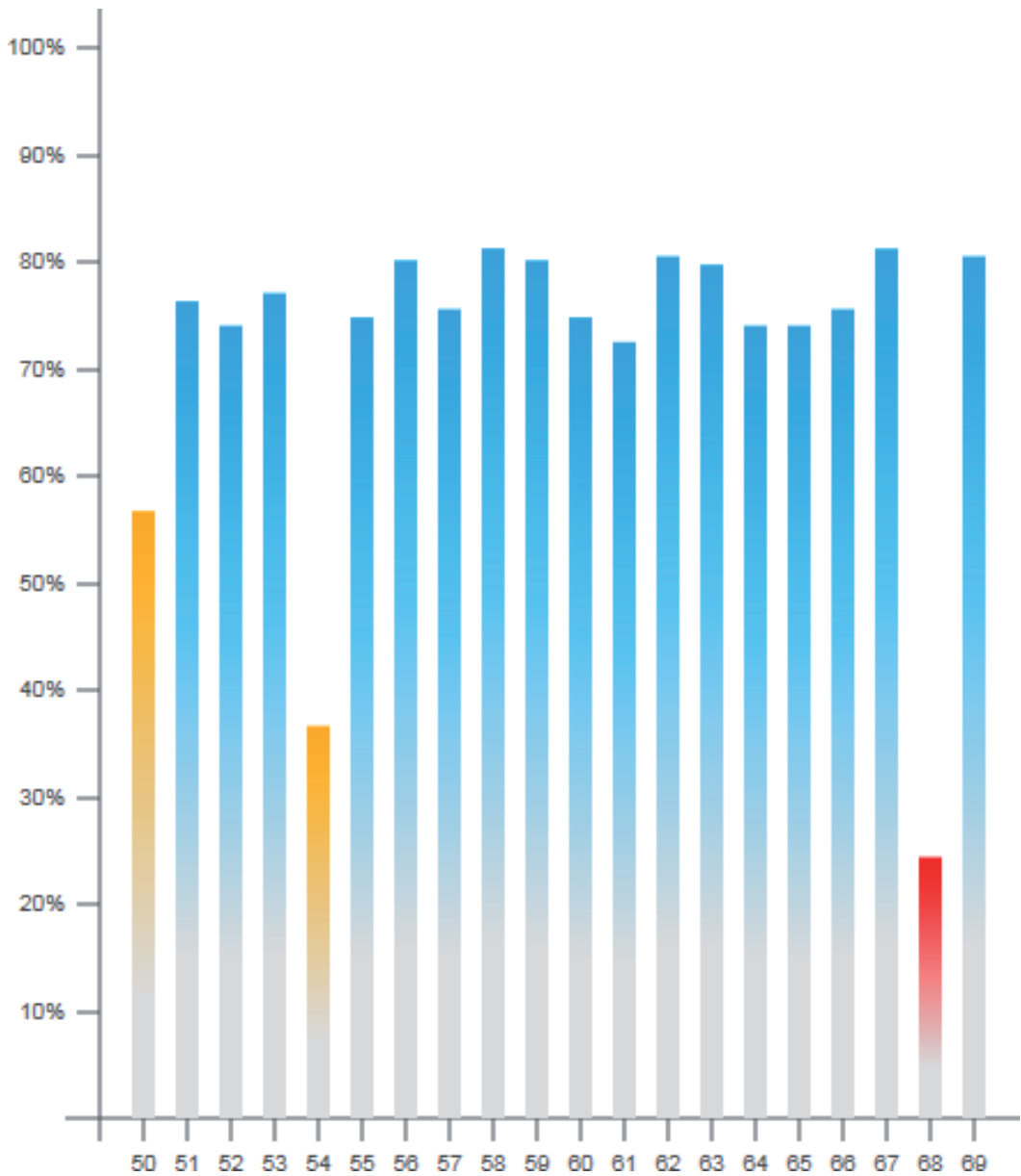

Several inverters in the same photovoltaic system can be compared in the current Comparison View.

The real-time inverter AC power is displayed as a percentage of the power from the solar module connected to the respective inverter (shown in a bar diagram). A bar is displayed for each inverter. The bar color indicates the power range of the inverter:

- Blue: the inverter power corresponds to the average power of all inverters.
- Yellow: the inverter power deviates slightly from the average power of all inverters (50–90% from the average).
- Red: the inverter power deviates significantly from the average power of all inverters or an error has occurred in the inverter (< 50% from the average).

## System Overview

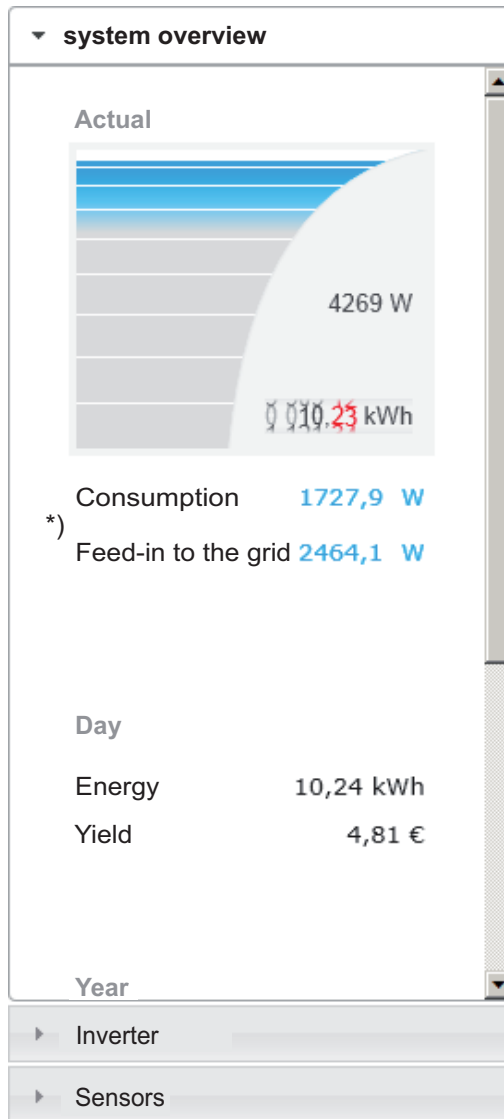

The system overview contains:

- the real-time power data of a photovoltaic system
- the active devices
- the energy generated per day, per year, and in total
- the yield per day, per year, and in total

\*) The values for consumption and energy fed into the grid are only displayed when a counter is configured on the inverter and the counter sends valid data.

## Inverter/Sensors View

### Inverter View





The Inverter View displays all the inverters present in the system.

\*) Clicking on an inverter or the corresponding bar in the Comparison View displays the inverter's real-time data:

Inverter 53	
Fronius IG Plus 150 V-3	
<b>Operational status</b>	Running
<b>Power</b>	8413 W
<b>Daily energy</b>	80 kWh
<b>Annual energy</b>	12 MWh
<b>Total energy</b>	36 MWh

### Sensor View

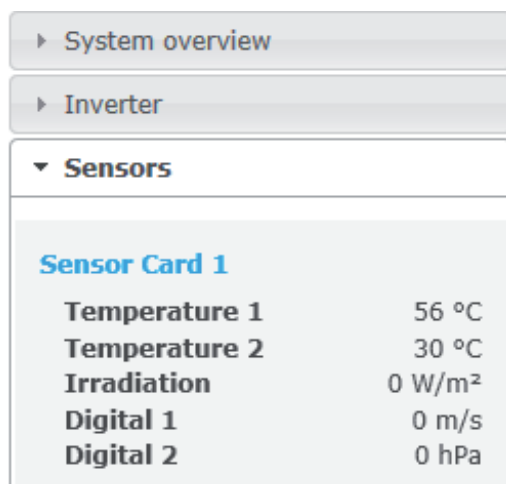





The Sensor View displays all the sensor cards/boxes present in the system.

# Services – System Information

## System Information

### System information

Datalogger ID	240.42435
Circuit board version	2.4A
Software version	3.3.5-22
System time	Oct 21 2014, 12:06:29 CEST
Uptime	3 d, 23 h, 48 min, 34 sec.
User agent	Mozilla/5.0 (compatible; MSIE 9.0; Windows NT 6.1; WOW64; Trident/5.0; SLCC2; .NET CLR 2.0.50727; .NET CLR 3.5.30729; .NET CLR 3.0.30729; Media Center PC 6.0; .NET4.0C; .NET4.0E)
Gateway	
DNS server	
LED states	   
LAN interface	
IP address	
Subnet mask	255.255.255.0
MAC address	00:03:AC:01:BF:49
WLAN interface	
IP address	
Subnet mask	
MAC address	00:06:C6:41:27:D3
GPIO	
IO-Name	I/O0 I/O1 I/O2 I/O3 I4 I5 I6 I7 I8 I9
IO-Direction	OUT OUT IN IN IN IN IN IN IN IN
IO-State	off off off off off off off off off off

Note: This device contains open source software.

For detailed information about the software being used and the requirements of the corresponding source code, please contact Fronius Tech Support.

(1)
  (2)

All settings except for the network  
 All settings

- (1) "Datalogger restart" button used to restart Fronius Datamanager
- (2) "Reset to factory settings" button
- (3) Option "All settings except for the network" is used to reset Fronius Datamanager to factory settings. The network settings and all items protected by the service user (UC Editor, counter settings, and the service password) are retained.
- (4) Option "Settings" is used to reset Fronius Datamanager and the network settings to factory settings. All items protected by the service user (UC Editor, counter settings, and the service password) are retained.

**IMPORTANT:** When Fronius Datamanager is reset to factory settings, the time and date settings must be checked.

# Services – Network Diagnostics

**Network Diagnostics** The Services / Network diagnostics option contains functions that are useful for diagnosing and correcting network problems. Ping and traceroute commands can be executed.

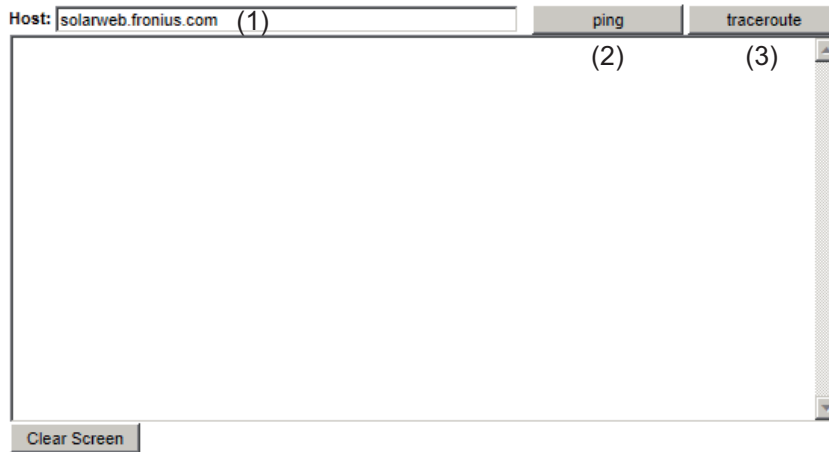

## The **ping** command

is used to determine whether or not a host is available and how much time a data transfer will take.

Sending a ping command:

- 1 Enter a host name or IP address in the "Host:" field (1)
- 2 Click on "ping" (2)
  - Ping command is sent
  - The resulting data is displayed

## A **traceroute** command

is used to determine the intermediate stations via which the data reaches the host.

Sending a traceroute command:

- 1 Enter a host name or IP address in the "Host:" field (1)
- 2 Click on "traceroute" (3)
  - Traceroute command is sent
  - The resulting data is displayed

# Services – Firmware Update

## General

You can update the Fronius Datamanager firmware under Services / Firmware Update. A firmware update can be performed via LAN or web.

## Firmware Update



### Configuration

- (1)  Automatic update search  (2)  
(3)  Use proxy server for Web update

### Update

- (4)  Update via Web  Update via LAN (5)

(6)

- (1) Automatic update search
- (2) "Check now" button (to search for updates manually)
- (3) Use proxy server for Web update

(3)  Use proxy server for Web update

(3a) Proxy server:

(3b) Port:

(3c) User:

(3d) Password:

- (3a) Field to enter the proxy server
- (3b) Field to enter the port
- (3c) Field to enter the user
- (3d) Field to enter the password
- (4) Carry out update via web
- (5) Carry out update via LAN

- Update via Web  Update via LAN (5)

(5a)

- (5a) Field to enter the IP address
- (6) "Run update" button to launch update process
- (7) "Apply/Save" button
- (8) "Cancel/Discard entries" button

## Automatic Update Search

**IMPORTANT:** An internet connection is required for the automatic update search.

When the "Automatic update search" option (1) is activated, Fronius Datamanager will automatically search for updates once a day. If new updates are available, a message is displayed under the other setting options for the Fronius Datamanager website.

## Firmware Update



### Configuration

(1)  Automatic update search

## Manual Update Search

When the "Automatic update search" function is deactivated, there will be no automatic search for updates.

1 To search manually for updates, use the "check now" button (2)

## Firmware Update



### Configuration

Automatic update search  (2)

## Firmware update via web

- 1 Open the Fronius Datamanager web page via a web browser
- 2 Open "Firmware update" under "Service"
- 3 Select "Update via web"
- 4 Click on the "Run update" button

The confirmation prompt for the update appears:

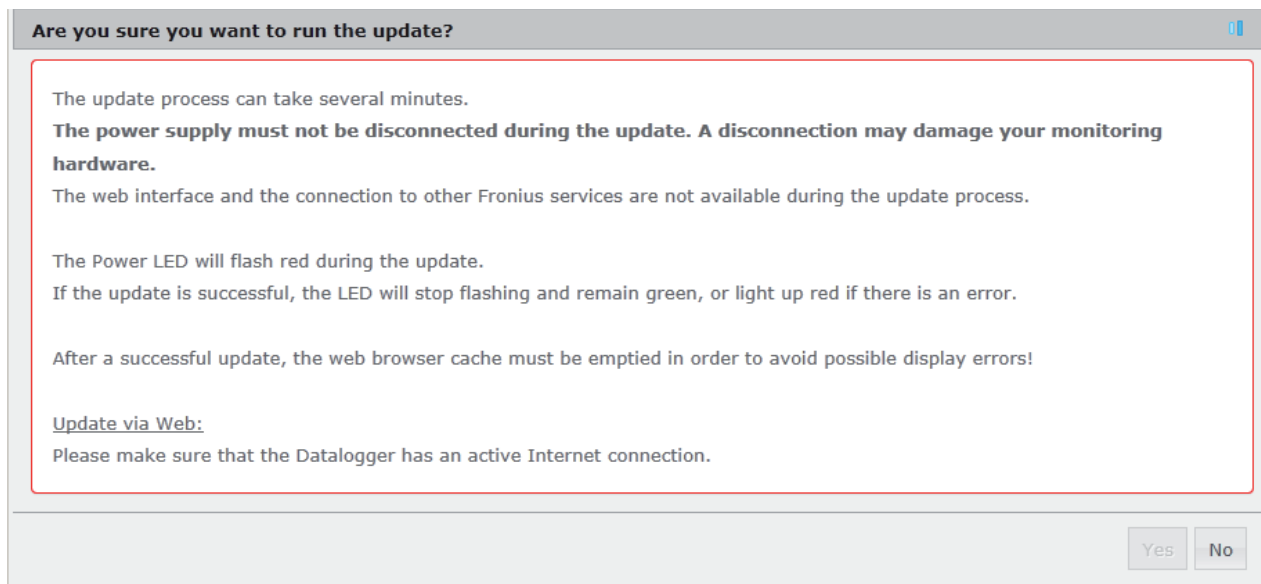

5 Click on the "Yes" button

The update starts. The update progress is displayed as a bar and a percentage.

**6** Once the update has been carried out successfully, click on the "Apply/Save" button

If the connection to the server fails:

- Deactivate the firewall for the duration of the update
- Retry the update

**IMPORTANT:** If a proxy server is used to connect to the internet:

- The "Use proxy server for Web update" option must be activated
- The required data must be entered

## Firmware Update via LAN

**1** Establish LAN connection between PC/laptop and Fronius Datamanager

**2** Download the current firmware from the Fronius homepage

**3** Run the downloaded update file on the PC/laptop

This will start a web server from which Fronius Datamanager will download the required files.

**4** Open the Fronius Datamanager web page via a web browser

**5** Open settings/firmware update

**6** Select "Update via LAN"

**7** Enter the IP address of the PC/laptop

**8** Click on the "Run update" button

The confirmation prompt for the update appears:

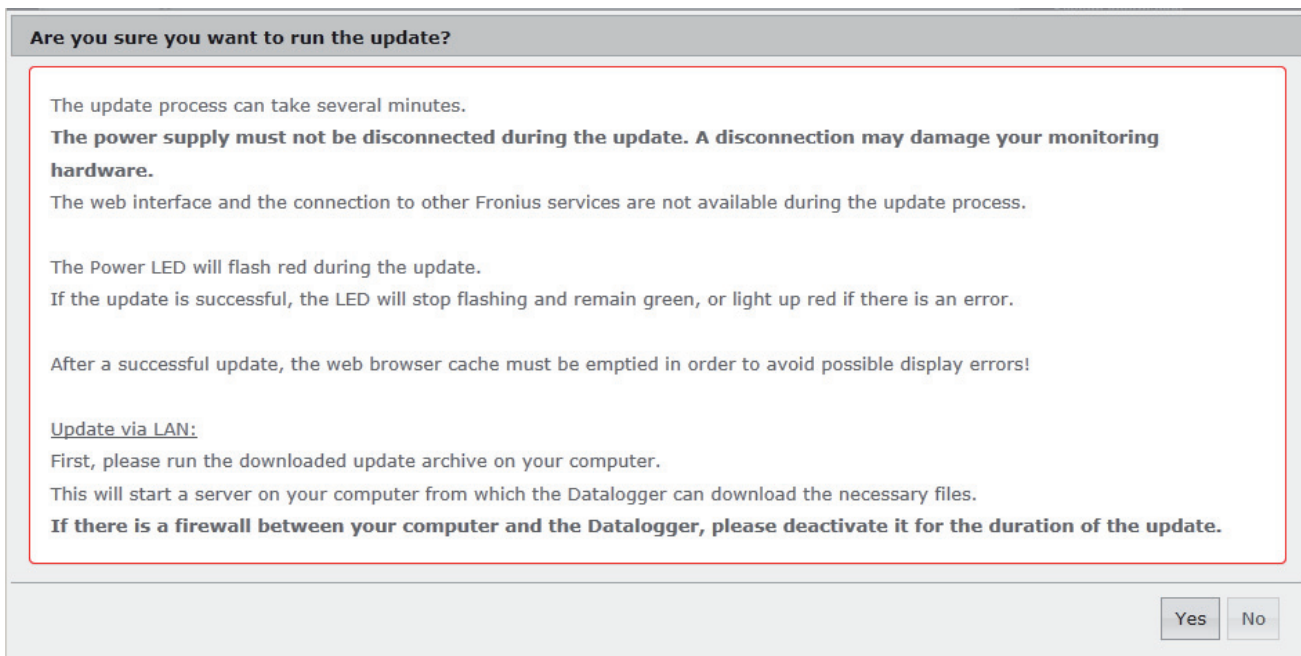

**9** Click on the "Yes" button

The update starts. The update progress is displayed as a bar and a percentage.

**10** Once the update has been carried out successfully, click on the "Apply/Save" button

The update is complete when the "Supply LED" lights up green.

If the connection to the server fails:

- Deactivate the firewall for the duration of the update
- Retry the update

# Services – Opening Wizards

**Opening Wizards** The Commissioning Wizard can be opened again and run under "Open Wizards."

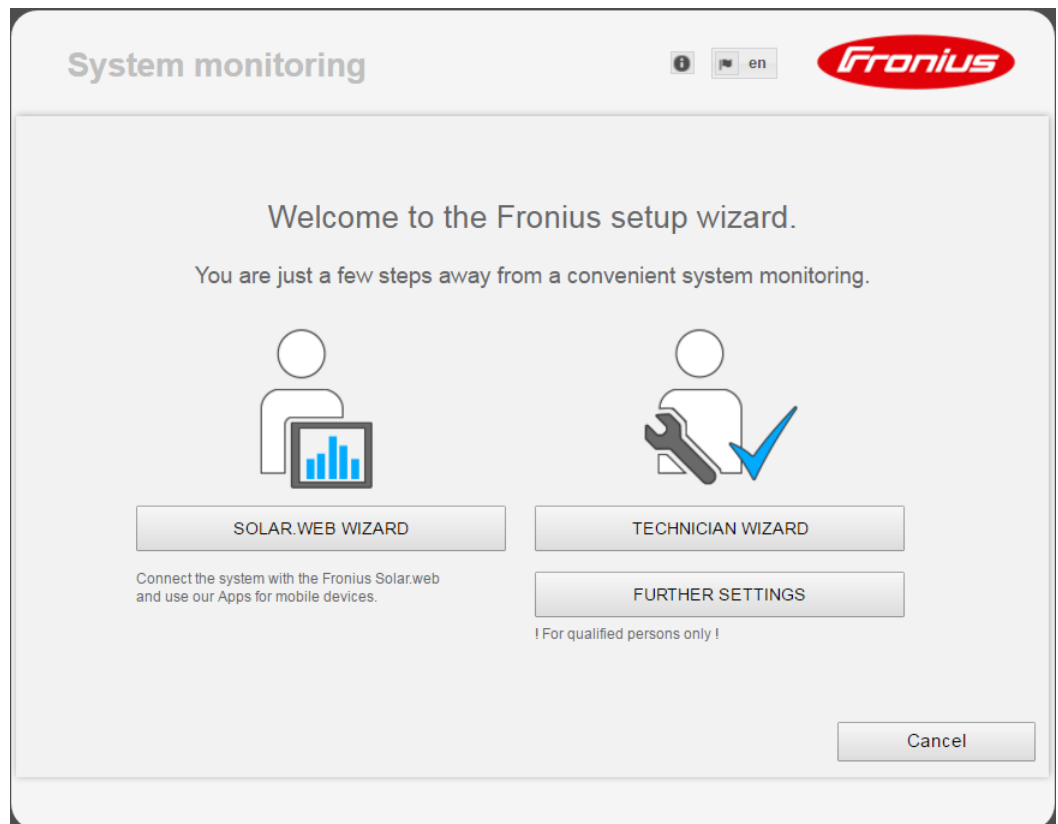

## **SOLAR WEB WIZARD**

For connecting the system to Fronius Solar.web and Fronius apps for mobile devices

## **TECHNICIAN WIZARD** (for trained personnel or specialists only)

For system settings

## **FURTHER SETTINGS** (for trained personnel or specialists only)

All settings for Fronius system monitoring

Click the "SOLAR WEB WIZARD" button to return to the original page.



# Settings – General

## General

### General

The screenshot shows the 'General' settings page. At the top right, there are two buttons: a checkmark button labeled (10) and a cross button labeled (11). Below these are two sections: 'Yield' and 'System time'. The 'Yield' section has two rows: 'Feed-in payment' with a text input (1) containing '0.12', a currency dropdown (2) set to '€ (EUR)', and a unit label '/kWh'; and 'Delivery costs' with a text input (3) containing '0.25' and a unit label '/kWh'. The 'System time' section has a 'Date / time \*' label, a date input (4) with '23.06.2014', an hour spinner (5) with '08', a colon separator, and a minute spinner (6) with '03'. Below the date input is a 'synchronisation' button (7). At the bottom is the 'Time zone settings' section with a 'Time zone \*' label, a region dropdown (8) set to 'Europe', and a location dropdown (9) set to 'Vienna'.

You can enter the charge rate per kWh (1), the currency (2) and the expenses per kWh (3) to calculate the yield under "Feed-in payment." The yield is shown in the current Total View.

The date (4), hour (5), and minutes (6) can be entered under "System time." Click "Synchronize" (7) to adapt the displayed time in the entry fields of the Fronius Data-manager web page to the time set on the computer operating system. Click the "Apply/Save" button (10) to apply the time.

The region (8) and location (9) for the time zone can be set under "Time zone settings."

- (10) "Apply/Save" button
- (11) "Cancel/Discard entries" button

\* Fields marked with \* are mandatory fields.

# Settings – Passwords

---

## General

Access to Fronius Datamanager is regulated by assigning passwords.

3 different password types are available:

- the administrator password
  - the service password
  - the user password
- 

## Passwords

### Passwords

(4)

User name  (1)

Old password \*

Password \*

Repeat password \*

---

(4)

User name  (2)

Old password \*

Password \*

Repeat password \*

---

(3)

Protect your system monitoring from unauthorized read access.

(1) Administrator password, user name = admin

The administrator password set during commissioning assigns the user read and write (configuration) access to Fronius Datamanager. The user can then open the "Settings" menu item and define any settings as desired, with the exception of the UC Editor and counter settings.

When an administrator password is set, the user must enter the user name and password in Fronius Datamanager to open the "Settings" menu item.

(2) Service password, user name = service

The service password is usually assigned in the Commissioning Wizard by the service technician or system installer and provides access to system-specific parameters. The service password is required to define counter settings and settings in the UC Editor. If no service password has been assigned, the Counter and UC Editor menu items cannot be accessed.

(3) After activating the selection field, the user password is displayed, user name = user.

---

Protect your system monitoring from unauthorized read access.

(3)  ✓ (4)

User name

Password \*

Repeat password \*

An assigned user password only gives the user read access to Fronius Dataman-ager. The user cannot open the "Settings" menu item.

When assigning a user password, users must enter their username and password every time they connect to Fronius Datamanager.

(4) "Apply/Save" button

# Settings – Inverter

## Views – Inverter

### Inverters

System name \*  (1)

(8)  (9)

(7)

No	visible	Device type	Device name	PV[Wp]
10 (2)	<input checked="" type="checkbox"/> (3)	IG 30 Dummy (4)	* <input type="text" value="IG 30 Dummy (10)"/> (5)	* <input type="text" value="2800"/> (6)

The data for the Comparison View is defined in "Inverter."

- (1) Field for assigning a system name \*
  - (2) Number of the inverter in Fronius Solar Net
  - (3) If the selection field is chosen, the inverter is displayed in the Comparison View
  - (4) Display of device type
  - (5) Field for assigning a device name \*
  - (6) Field for entering the solar module power in W \*
  - (7) "Set all" button
  - (8) "Apply/Save" button
  - (9) "Cancel/Discard entries" button
- \* Fields marked with \* are mandatory fields.

# Settings – Fronius Sensor Cards

## Sensor Cards

### Fronius Sensor Cards

(4) (5)

Fronius Sensor Card 1 (1)  
(2)

Measurement channel (2)	Channel name (3)
Temperature 1	Temperature 1
Temperature 2	Temperature 2
Irradiation	Irradiation
Digital 1	Digital 1
Digital 2	Digital 2
Current	Current

A specific channel name can be assigned to each sensor value of a Fronius Sensor Card/Box in "Sensor Cards" (e.g., wind speed).

- (1) Sensor Card selection
- (2) Displayed measuring channel
- (3) Fields for assigning the channel name
- (4) "Apply/Save" button
- (5) "Cancel/Discard entries" button

# Settings – Fronius Solar.web

## Solar.web

The Solar.web menu item can be used to make a direct connection between Fronius Data-manager and Fronius Solar.web.

## Fronius Solar.web



### Datalogging settings

Query cycle inverter  (1)

Query cycle Fronius Sensor Cards  (2)

logged [delete logged data ...](#)  
(3)

### Send actual data to Fronius Solar.web

No  Yes  
(4)

### Send archive data to Fronius Solar.web

never  daily  hourly

(5) (6) (7)

register at [Solar.web ...](#)

(8)

### Datalogging settings

- (1) Selection of query cycle for the inverter:  
Data queries every 5/10/15/20/30 minutes
- (2) Selection of query cycle for Fronius Sensor Cards:  
Data queries every 5/10/15/20/30 minutes
- (3) "Delete log data" button  
After clicking the "Delete log data" link, a security prompt appears to confirm the deletion of the log data.
- (4) Selection of whether current data is sent to Fronius Solar.web

### Send archived data to Fronius Solar.web

- (5) Never
- (6) Daily  
After the selection field is activated the setting options are displayed:

never  daily  hourly

(6)

at  (6a)

on  Monday  Tuesday  Wednesday  Thursday  Friday  Saturday  Sunday

(6b)

- (6a) Field for entering the time (hour)
- (6b) Fields for selecting the weekdays
- (7) Hourly  
After the selection field is activated the setting options are displayed:

never  daily  hourly

(7)

00:00  01:00  02:00  03:00  04:00  05:00  06:00  07:00  
(7a)  08:00  09:00  10:00  11:00  12:00  13:00  14:00  15:00  
 16:00  17:00  18:00  19:00  20:00  21:00  22:00  23:00

(7a) Fields for selecting the time (hour)

(8) "Register Solar.web" button  
Clicking this link opens the Fronius Solar.web start page; data relevant for Fronius Solar.web is automatically sent as well.

(9) "Apply/Save" button

(10) "Cancel/Discard entries" button

# Calculating memory capacity

---

**Memory capacity** The Fronius Datamanager has a memory capacity of up to 5 years and 7 months for a PV system with one inverter and a save interval of 15 minutes. However, the memory capacity is reduced accordingly depending on the number of inverters and/or Fronius sensor cards/boxes that are integrated into the system.

---

**Calculating memory capacity**

- 1** Determine logging points for inverters and Fronius sensor cards/boxes

$$\text{Logging points per day} = \frac{\text{Logging duration [min]}}{\text{Save interval [min]}}$$

Logging duration [min]

- For inverters: e.g., 14 hours = 840 minutes
- For Fronius Sensor Card/Fronius Sensor Box: 24 hours = 1440 minutes

- 2** Establish total of logging points

$$\begin{aligned} \text{Total of logging points} &= \\ &= (\text{number of inverters} \times \text{logging points per day}) + (\text{number of Fronius Sensor Cards /} \\ &\quad \text{boxes} \times \text{logging points per day}) \end{aligned}$$

- 3** Determine memory sectors per day

$$\text{Memory sectors per day} = \frac{\text{Total of logging points}}{114}$$

- 4** Round to whole numbers

- 5** Determine memory capacity

$$\text{Memory capacity [days]} = \frac{2048}{\text{Memory sectors per day}}$$

**Calculation example**

2 inverters, logging duration = 14 hours (840 minutes)  
 1 Fronius Sensor Card, logging duration = 24 hours (1440 minutes)

Save interval = 15 minutes

1. Logging points per day:

$$\text{Inverter logging points} = \frac{840 \text{ min}}{15 \text{ min}} = 56$$

$$\text{Sensor Card logging points} = \frac{1440 \text{ min}}{15 \text{ min}} = 96$$

2. Total logging points:



$$\text{Total logging points} = (2 \times 56) + (1 \times 96) = 208$$

(2 x 56) ... 2 inverters, (1 x 96) ... 1 Sensor Card

3. Memory sectors per day:

$$\text{Memory sectors} = \frac{208}{114} = 1,825$$

4. Rounded:

$$1,825 \quad \Rightarrow \quad 2$$

5. Memory capacity [days]:

$$\text{Memory capacity} = \frac{2048}{2} = 1024 \text{ days (= 2 years, 9 months, 18 days)}$$

$$\text{Memory capacity [days]} = \frac{2048}{\text{Memory sectors per day}}$$

# Settings – Service Messages

## General

Service messages, inverter errors, the Fronius String Control, etc., are sent to Fronius Datamanager and saved. The "Service messages" selection option is used to define how service messages are communicated. They can be communicated via:

- E-mail
- SMS

Service messages can be analyzed further using Fronius Solar.web.

## Service Messages

### Service messages

- (1) Message to e-mail recipient  
Activate to send service messages to one or more e-mail addresses
- (2) Field for up to a max. of 10 e-mail addresses  
Separate e-mail addresses with ";"
- (3) Selection field to determine whether the service message will be sent immediately via e-mail or at a specific time  
If "daily" is selected, the selection options for the time (hour) are also displayed.
- (4) "Send test e-mail" button  
Sending a test e-mail may take several minutes.
- (5) Message to SMS recipient  
Activate to send service messages as an SMS to a telephone number
- (6) Field to enter the country code  
e.g.: +43 = country code for Austria
- (7) Field to enter area code
- (8) Field to enter the telephone number
- (9) Field for sending daily
- (10) Selection field for the time (hour) at which a service message is to be sent via SMS

- (11) "Send test SMS" button  
Sending a test SMS may take several minutes.
- (12) Selection field for the language in which the service message will be sent
- (13) "Apply/Save" button
- (14) "Cancel/Discard entries" button

# Settings – Network

## General

The "Network" menu item is used to determine the type of internet connection (LAN or WLAN).

**IMPORTANT!** If the IP address is obtained statically, a gateway and a DNS server must be entered for the selected connection mode (Internet via WLAN or LAN).

## Network

### Network interfaces

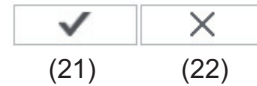

#### Internet connection

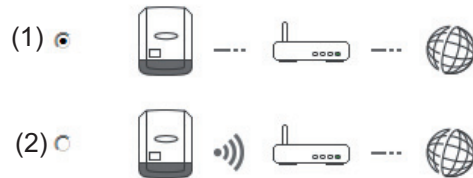

#### LAN

(3) (4)

Get address  static  dynamic

Host name  (5)

IP-Address  (6)

Subnet-mask  (7)

Gateway  (8)

DNS-Server  (9)

#### WLAN

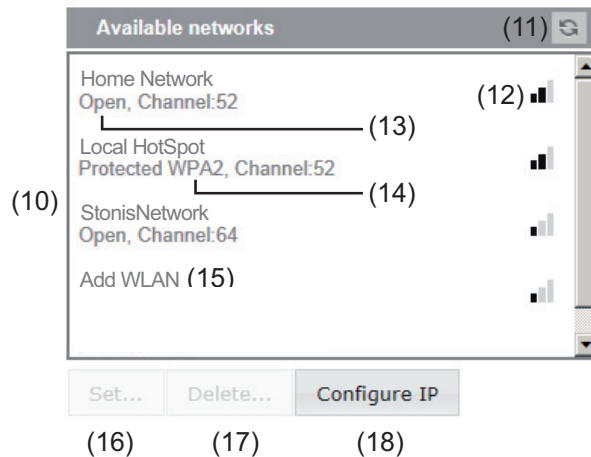

- (1) Internet connection via LAN
- (2) Internet connection via WLAN

#### LAN

- (3) Obtain IP address statically  
The user enters a fixed IP address for Fronius Datamanager and also manually sets the subnet mask, gateway address, and DNS server address (from the provider).
- (4) Obtain IP address dynamically  
Fronius Datamanager obtains its IP address from a DHCP server (DHCP = dynamic host configuration protocol).  
The DHCP server must be configured so that Fronius Datamanager is always assigned the same IP address. You will then always know the IP address at which Fronius Datamanager can be found.  
If the DHCP server supports the "DNS dynamic updates" function, a name can be entered for Fronius Datamanager in the "Host name" field. The connection to Fronius Datamanager can then be established using the name instead of the IP address.  
For example: Host name = sample\_system, Domain name = froni.us.com.  
The Fronius Datamanager can be reached via the address "sample\_system.froni.us.com".
- (5) Field for entering a host name for dynamically obtained IP address
- (6) Field for entering the IP address for static IP address
- (7) Field for entering the subnet mask for static IP address
- (8) Field for entering the gateway for static IP address
- (9) Field for entering the DNS server for static IP address

### **WLAN**

- (10) Display of detected WLAN networks
- (11) "Refresh" button  
Used to search again for available WLAN networks
- (12) Display of signal quality  
One bar = low signal strength  
Three bars = high signal strength
- (13) Network status  
Open/secured/saved (after pressing the "Setup" button (16))
- (14) Display of encryption  
WPA / WPA2 / WEP
- (15) Add WLAN  
Used to display hidden networks  
Clicking this option opens the "WLAN connection" window

**WLAN Connection**

Network: (15a) My hidden network

Security: WPA1/2 (15b)

Enter password: ●●●●●●●● (15c)

Show password:  (15d)

(15e) Save Cancel (15f)

- (15a) Name of hidden WLAN network
  - (15b) Selection field for encrypting the hidden WLAN network
  - (15c) Field for entering the password for the hidden WLAN network
  - (15d) Selection field for whether the password is displayed
  - (15e) "Save" button
  - (15f) "Cancel" button
- (16) "Setup" button  
Used to save a selected WLAN network;  
Clicking this option opens the "WLAN connection" window

**WLAN Connection**

Network: Home Network (16a)

Signal quality: good (16b)

Security: WPA2 (16c)

Enter password: ●●●●●●●● (16d)

Show password:  (16e)

(16f) Save Cancel (16g)

- (16a) Name of selected WLAN network
  - (16b) Signal strength of selected WLAN network
  - (16c) Encryption of selected WLAN network
  - (16d) Field for entering the password for the WLAN network
  - (16e) Selection field for whether the password is displayed
  - (16f) "Save" button
  - (16g) "Cancel" button
- (17) "Remove" button  
Used to delete a saved WLAN network
- (18) "Configure IP" button  
Clicking this option opens the "Configure IP" window

The image shows a 'Configure IP' dialog box with the following elements and callouts:

- (3)** points to the 'static' radio button.
- (4)** points to the 'dynamic' radio button.
- (5)** points to the 'Host name' text box containing 'meineanlage'.
- (6)** points to the empty 'IP-Address' text box.
- (7)** points to the 'Subnet-mask' text box containing '255.255.255.0'.
- (8)** points to the empty 'Gateway' text box.
- (9)** points to the empty 'DNS-Server' text box.
- (19)** points to the 'OK' button.
- (20)** points to the 'Cancel' button.

- (19) "OK" button
- (20) "Cancel" button
- (21) "Apply/Save" button
- (22) "Cancel/Discard entries" button

# Settings – Energy Manager

## General

The output I/O 1 can be used to control an actuator (e.g., relay, contactor) via the "Load Management" function.  
A load connected to I/O 1 can thus be controlled by assigning a power feed-dependent switch-on or switch-off point.

## Load Management

### Energy Manager

(14)   (15)

**Output: IO-1**
State: off (16)

**Controlling**

(1)  deactivated

(2)  by power production

(3)  by power surplus (in case of feed-in limits)

**Thresholds**

on: (4)  W

off: (5)  W

**Duration**

(6)  Minimum duration per on-signal:  Minutes (7)

(8)  Maximum duration per day:  Minutes (9)

**Desired duration**

(10) per day: (11)  Minutes

is to finish by: (12)  :   (13)

#### Controlling

- (1) Control via Energy Manager is deactivated.
- (2) Control via Energy Manager is effected by the power generated.
- (3) Control via Energy Manager is effected by excess power (given feed limits). This option can only be selected if a counter has been connected. Control via Energy Manager is effected using the actual power of feeding in with respect to the grid.

#### Thresholds

- (4) On:  
For entering an effective power limit, at which the I/O 1 output is activated.
- (5) Off:  
For entering an effective power limit, at which the I/O 1 output is deactivated.

#### Duration

- (6) Field for activating the minimum runtime for each switch-on process



- (7) Field for entering a minimum time for which the output I/O 1 is to be activated for each switch-on process
- (8) Field for activating the maximum runtime per day
- (9) Field for entering a maximum time for which the output I/O 1 is to be activated in total per day (several switch-on processes are included).

**Deired duration**

- (10) Field for activating a target runtime
- (11) Field for entering a minimum time for which the output I/O 1 is to be activated in total per day (several switch-on processes are included)
- (12) Field for selecting the hour, if the target runtime is to be achieved by a certain time
- (13) Field for selecting the minute, if the target runtime is to be achieved by a certain time
- (14) "Apply/Save" button
- (15) "Cancel/Discard entries" button
- (16) Status display  
If the mouse pointer is moved over the status, the reason for the current status is displayed.

If "by excess power" is selected under "Control", additional selection fields for Feed (3a) and Reference (3b) are displayed under "Thresholds":

(3)  by power surplus (in case of feed-in limits)

**Thresholds**

on: (3a)   w (4)

off: (3b)   w (5)

# Settings – Push Service

**Push Service** This function can be used to export current and log data in different formats or with different protocols to an external server.

## Push Service

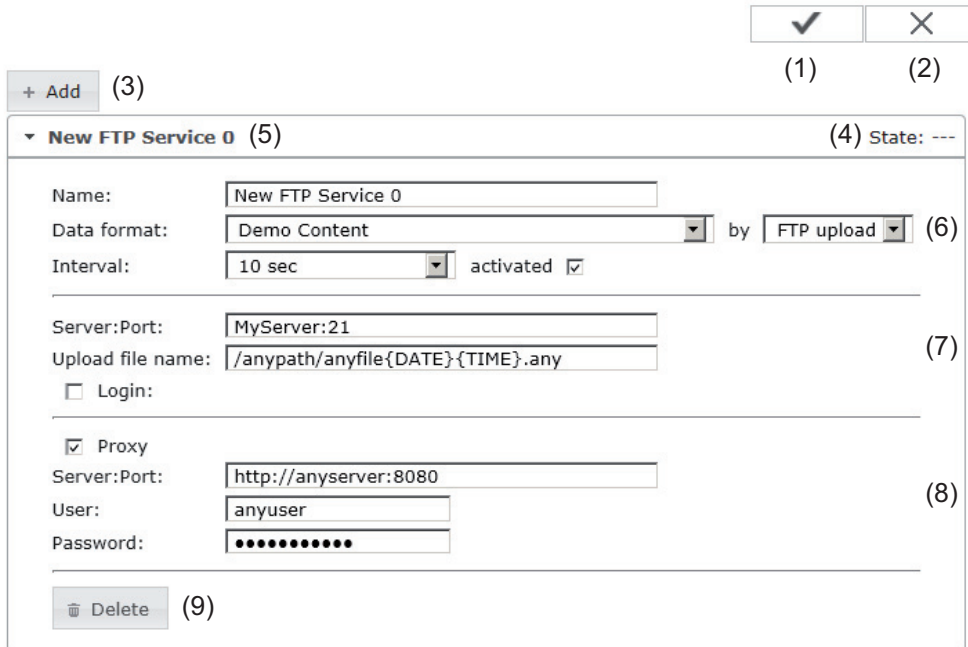

- (1) "Apply/Save" button
- (2) "Cancel/Discard entries" button
- (3) "Add" button  
Clicking this button adds a new push service job. The new job is saved by clicking the "Apply/Save" button (1).
- (4) State  
Displays the current status of the push service job in question
- (5) Displayed name of push service job
- (6) Area for entering general data:
  - Name (name of push service job)
  - Data format
  - Protocol type (FTP upload/HTTP POST)
  - Interval
  - Activation status
- (7) Area for entering the target data:
  - Server port
  - Upload file name
  - Login (user/password)

- (8) Area for entering the proxy data:  
Server port  
User  
Password
  
- (9) "Delete" button  
Clicking this button deletes the selected push service job

---

**Further Information about the Push Service Function**

Further information about the push service function can be found in the following operating instructions:

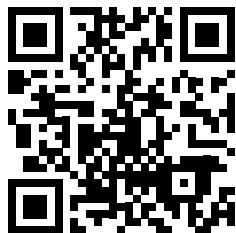

<http://www.fronius.com/QR-link/4204102152>

42.0410.2152  
Fronius Push Service

# Modbus Settings

## General

From your web browser, you can use the Fronius Datamanager web page to apply the Modbus connection settings which cannot be accessed via the Modbus protocol.

## Additional Information on the Modbus Function

For additional information on the Modbus function, please see the following operating instructions:

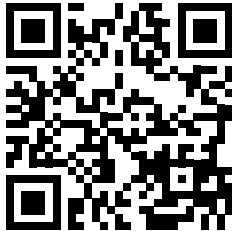

<http://www.fronius.com/QR-link/4204102049>

42,0410,2049

Fronius Datamanager Modbus connection

## Data Output via Modbus

### Modbus

Data export via Modbus  off  tcp

(1) (2)

(4) (5)

### Control priorities overview

1 2 3

Ripple control signal receiver

Dynamic power reduction    (3)

Controlling via Modbus

### Data Output via Modbus

Activation of the Modbus service and selection of the transmission protocol. If the Modbus service is activated, additional entry fields are available.

(1) **off**  
No data output via Modbus

(2) **tcp**  
Data output via Modbus TCP

Data export via Modbus  off  tcp

Modbus port  (2a)

String control address offset  (2b)

Sunspec Model Type (2c)  float  int + SF

Demo mode  (2e)

Inverter control via Modbus  (2f)

(2a) **Modbus port**  
Number of the TCP port which must be used for Modbus communication.

- (2b) **String Control address offset**  
Offset value used to assign addresses to Fronius String Controls via Modbus. For further details, see the section entitled "Modbus Device ID for Fronius String Controls."

**Sunspec model type**

Used to select the data type of data models for inverters.

- (2c) **float**  
Display as floating-point numbers  
SunSpec Inverter model I111, I112 or I113
- (2d) **int+SF**  
Display as integers with scaling factors  
SunSpec Inverter model I101, I102 or I103

**IMPORTANT!** Since the different models have different numbers on registers, the register addresses of all the subsequent models also change when the data type is changed.

- (2e) **Demo mode**  
The demo mode is used to implement or validate a Modbus master. It enables you to read inverter and String Control data without actually connecting or activating a device. The same data is always sent back for all the registers.
- (2f) **Inverter control via Modbus**  
If this option is activated, the inverter can be controlled via Modbus. The "Limit Control" selection field is displayed. Inverter control includes the following functions:
  - On/off
  - Power reduction
  - Setting a constant power factor (cos phi)
  - Setting a constant reactive power

- (3) **Control priorities**  
Used to specify which service is given priority by the inverter control unit.  
  
1 = highest priority, 3 = lowest priority

The control priorities can only be changed in the **UC EDITOR** menu item.

- (4) **"Apply/Save" button**
- (5) **"Cancel/Discard entries" button**

**Limit Control**

The "Limit Control" option is only available for the TCP transmission protocols. It is used to block inverter control commands from unauthorized users by only permitting control for specific devices.

Inverter control via Modbus	<input checked="" type="checkbox"/>	
Restrict the control	<input checked="" type="checkbox"/>	(1)
IP adress	<input type="text" value="10.5.34.1"/>	(2)

(1) **Limit Control**

If this option is activated, only certain devices will be able to send control commands.

(2) **IP address**

To limit inverter control to one or more devices, enter the IP addresses of the devices which are permitted to send commands to Fronius Datamanager in this field. Multiple entries are separated by commas.

Examples:

- one IP address: **98.7.65.4**
  - Control only permitted by IP address *98.7.65.4*
- Several IP addresses: **98.7.65.4, 222.44.33.1**
  - Control only permitted by IP addresses *98.7.65.4 and 222.44.33.1*
- IP address range, e.g., from 98.7.65.1 to 98.7.65.254 (CIDR notation):  
**98.7.65.0/24**
  - Control only permitted through IP addresses *98.7.65.1 to 98.7.65.254*

---

**Save or Reject Changes**



Saves the changes and displays a message confirming this.  
If you exit the "Modbus" section without saving your changes, all the changes you have made will be rejected.



Prompts you to confirm whether or not you wish to reject the changes you have made and then reinstates the most recently saved values.

# Settings – Counter

## General

**IMPORTANT!** Settings in the “Counter” menu item may only be entered by staff trained to do so!

The service password must be entered for the “Counter” menu item.

Three-phase or one-phase Fronius Smart Meters may be used. In both cases, selection is made via the “Fronius Smart Meter” item. The Fronius Datamanager automatically detects the counter type.

A primary meter or, optionally, multiple secondary meters can be chosen. The primary meter must be configured before a secondary meter can be chosen.

## Counter

### Meter settings



Click [here](#) for circuit diagrams of the meter installation (2)

- (1) Field for selecting a counter:
  - None selected
  - S0 inverter (for Fronius Galvo, Fronius Symo, Fronius Primo, and Fronius Eco inverters only)
- (2) Link to counter circuit diagrams
- (3) "Apply/Save" button
- (4) "Cancel/Discard entries" button

## S0 Inverter

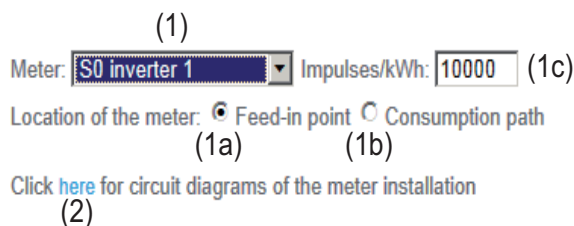

- (1a) Counter position at feed-in point  
 The power of feeding in and energy are measured. The consumption is determined using these values and the system data.  
 An S0 counter must be configured at this position in order to count the fed-in energy.

**IMPORTANT!** If you are using an S0 counter at the feed-in point, the counter data will not be displayed on Fronius Solar.web. This option is only provided for dynamic power reduction.

The consumption values can be detected to a limited extent when feeding into the grid.

- (1b) Counter position in consumption branch  
 The power consumed and energy are measured directly. The power of feeding in and energy are determined using these values and the system data.  
 An S0 counter must be configured at this position in order to count the energy consumed.

- (1c) Field for entering the impulses per kWh

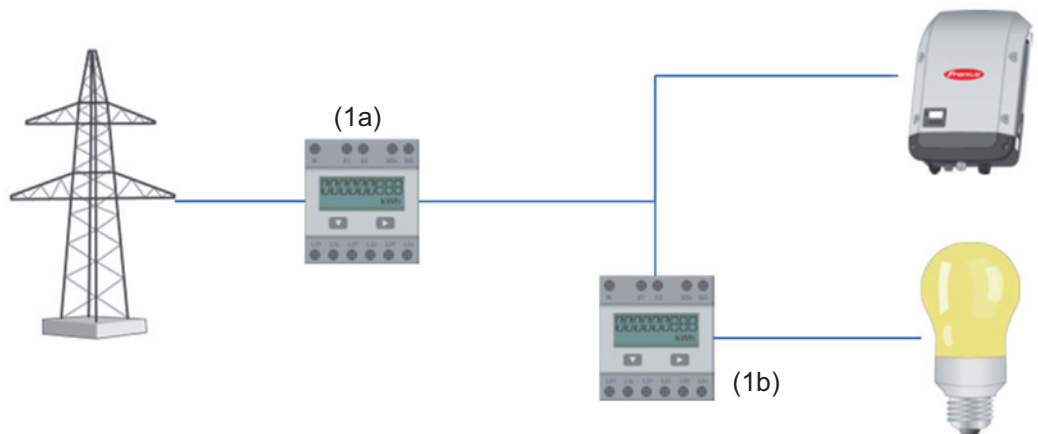

A counter for recording self-consumption per S0 can be connected directly to the inverter (for Fronius Galvo, Fronius Symo, Fronius Primo, and Fronius Eco only).

**IMPORTANT!** An S0 counter is connected to the switchable multifunctional current interface of the inverter. Connecting an S0 counter to the inverter may require an inverter firmware update.

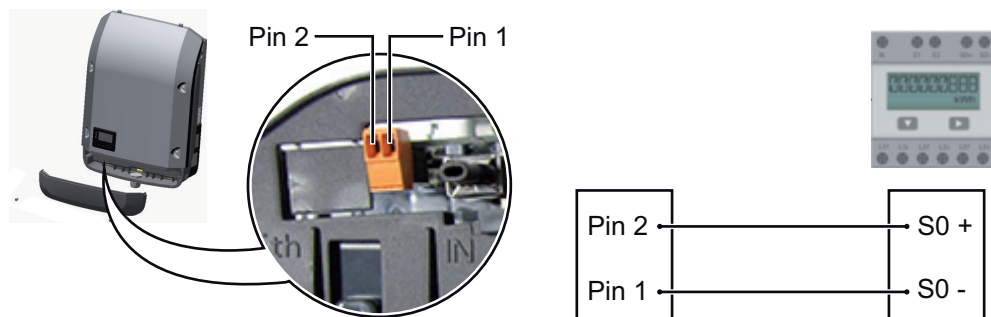

Requirements for the S0 counter:

- Must meet standard IEC 62053-31 Class B
- Max. voltage: 15 V DC
- Max. current when ON: 15 mA
- Min. current when ON: 2 mA
- Max. current when OFF: 0.15 mA



Recommended max. impulse rate of S0 counter:

PV power kWp [kW]	Max. impulse rate per kWp
30	1000
20	2000
10	5000
≤ 5.5	10,000

# Settings – DNO Editor

## General

In the "DNO editor" menu item, settings relevant to a utility company are made. An effective power limit in % and/or a power factor limit can be set.

**IMPORTANT!** Settings in the "DNO editor" menu item may only be made by staff trained to do so!

The service password must be entered for the "DNO editor" menu item.

## UC Editor – IO Control

### UC editor

My System, at Mittwoch, 26. März 2014, 08:47:45

(11)   (12)

(1)	(2)	(3)	(4)	(5)	(6)	(7)
IO control	Input pattern	Active power	Power factor cosφ	UC output	excluded inverter(s)	
	1 2 3 4 5 6 7 8			I/O 0		
<input checked="" type="checkbox"/>	<input checked="" type="checkbox"/> <input checked="" type="checkbox"/> <input type="checkbox"/> <input type="checkbox"/> <input type="checkbox"/> <input type="checkbox"/> <input type="checkbox"/> <input type="checkbox"/>	<input checked="" type="checkbox"/> 100 %	<input type="checkbox"/> 1 <input type="radio"/> ind <input checked="" type="radio"/> cap	<input checked="" type="checkbox"/>	<input type="text"/>	<input type="button" value="−"/>
<input checked="" type="checkbox"/>	<input type="checkbox"/> <input type="checkbox"/> <input checked="" type="checkbox"/> <input type="checkbox"/> <input type="checkbox"/> <input type="checkbox"/> <input type="checkbox"/> <input type="checkbox"/>	<input checked="" type="checkbox"/> 60 %	<input type="checkbox"/> 1 <input type="radio"/> ind <input checked="" type="radio"/> cap	<input checked="" type="checkbox"/>	<input type="text"/>	<input type="button" value="−"/>
<input checked="" type="checkbox"/>	<input type="checkbox"/> <input type="checkbox"/> <input type="checkbox"/> <input checked="" type="checkbox"/> <input type="checkbox"/> <input type="checkbox"/> <input type="checkbox"/> <input type="checkbox"/>	<input checked="" type="checkbox"/> 30 %	<input type="checkbox"/> 1 <input type="radio"/> ind <input checked="" type="radio"/> cap	<input checked="" type="checkbox"/>	<input type="text"/>	<input type="button" value="−"/>
<input checked="" type="checkbox"/>	<input type="checkbox"/> <input type="checkbox"/> <input type="checkbox"/> <input type="checkbox"/> <input checked="" type="checkbox"/> <input type="checkbox"/> <input type="checkbox"/> <input type="checkbox"/>	<input checked="" type="checkbox"/> 0 %	<input type="checkbox"/> 1 <input type="radio"/> ind <input checked="" type="radio"/> cap	<input checked="" type="checkbox"/>	<input type="text"/>	<input type="button" value="−"/>
<input type="checkbox"/>	<input type="checkbox"/> <input type="checkbox"/> <input type="checkbox"/> <input type="checkbox"/> <input type="checkbox"/> <input type="checkbox"/> <input type="checkbox"/> <input type="checkbox"/>	<input type="checkbox"/> %	<input type="checkbox"/> <input type="radio"/> ind <input checked="" type="radio"/> cap	<input type="checkbox"/>	<input type="text"/>	<input type="button" value="+"/>

... not applicable
  ... not considered
  ... pin open
  ... pin closed

UC Editor – Factory setting with 100%, 60%, 30%, and 0% effective power. The settings can be changed at any time.

- (1) Activating the rule
- (2) Input pattern (assignment of individual I/Os)
  - 1 click = white
  - 2 clicks = blue
  - 3 clicks = gray

The virtual IO assignment is displayed as described in the "Settings – IO Assignment" section. The display may be different in older versions of the software.

- (3) First activate effective power, then enter the desired effective power as a %

- (4) First activate power factor  $\cos \phi$ ,  
then enter the desired power factor and select "ind" or "cap"
- ind = inductive  
cap = capacitive
- (5) UC output (feedback output)  
When the rule is activated, the I/O 0 output will be activated (e.g., for operating a signal device)
- (6) Excluded inverter  
Enter the numbers of the inverters that should be excluded from the rule here. Separate multiple inverters with a comma.
- (7) Delete/add a new rule  
+ = add a new rule  
- = delete the currently selected rule
- (8) Legend for use of colors
- (9) Click "Import" button  
to import rules in \*.fpc format
- The function of the "Import" button depends on the browser used, e.g., Firefox and Google Chrome support the function.
- (10) Click "Export" button  
to save the rules separately in \*.fpc format
- (11) "Apply/Save" button
- (12) "Cancel/Discard entries" button

The print function of the web browser can be used to save the UC Editor settings as a PDF or print them out (e.g., as a commissioning report).

### Connection Example

- (1) Ripple control signal receiver with 3 relays for effective power limitation  
(2) Ripple control signal receiver with 3 relays for power factor limitation  
(3) I/Os on Fronius Datamanager  
(4) Loads (e.g., signal light, signal relay)

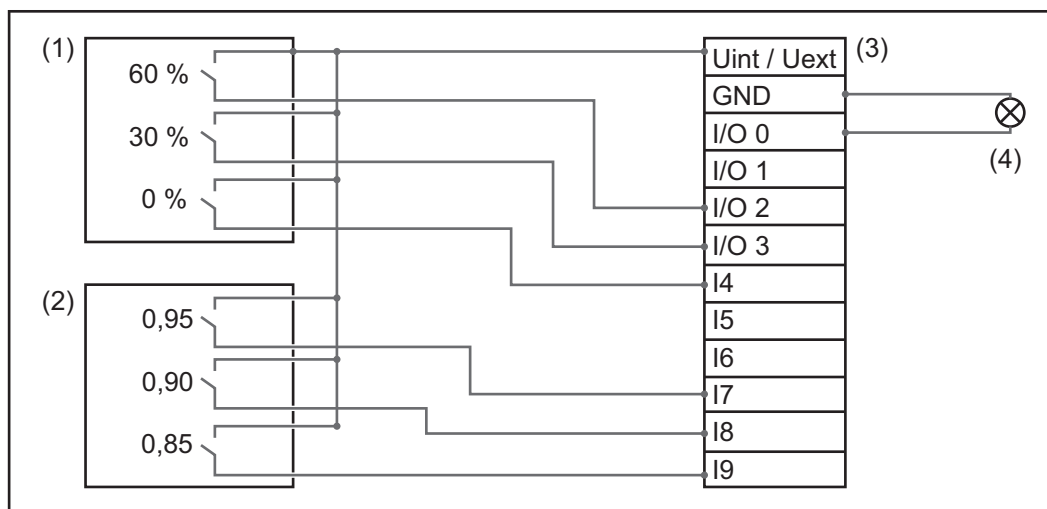

The ripple control signal receiver and the 'Fronius Datamanager' plug are connected to one another using a 4-pin cable in accordance with the connection diagram. For distances of greater than 10 m between 'Fronius Datamanager' and the ripple control signal receiver, a shielded cable is recommended.

Settings on the UC Editor:

Approved	Input pattern									Effective power	Power factor cosφ		PSC output	Excluded inverters		
	I/O 0	I/O 1	I/O 2	I/O 3	I 4	I 5	I 6	I 7	I 8		I 9					ind
↑	<input checked="" type="checkbox"/>	<input checked="" type="checkbox"/>	<input checked="" type="checkbox"/>	<input checked="" type="checkbox"/>	<input type="checkbox"/>	<input type="checkbox"/>	<input type="checkbox"/>	<input type="checkbox"/>	<input type="checkbox"/>	<input type="checkbox"/>	<input checked="" type="checkbox"/> 60 %	<input type="checkbox"/> 1	<input type="radio"/> ind <input checked="" type="radio"/> cap	<input checked="" type="checkbox"/>		-
(1)	<input checked="" type="checkbox"/>	<input checked="" type="checkbox"/>	<input checked="" type="checkbox"/>	<input checked="" type="checkbox"/>	<input type="checkbox"/>	<input type="checkbox"/>	<input type="checkbox"/>	<input type="checkbox"/>	<input type="checkbox"/>	<input type="checkbox"/>	<input checked="" type="checkbox"/> 30 %	<input type="checkbox"/> 1	<input type="radio"/> ind <input checked="" type="radio"/> cap	<input checked="" type="checkbox"/>		-
↓	<input checked="" type="checkbox"/>	<input checked="" type="checkbox"/>	<input checked="" type="checkbox"/>	<input checked="" type="checkbox"/>	<input type="checkbox"/>	<input type="checkbox"/>	<input type="checkbox"/>	<input type="checkbox"/>	<input type="checkbox"/>	<input type="checkbox"/>	<input checked="" type="checkbox"/> 0 %	<input type="checkbox"/> 1	<input type="radio"/> ind <input checked="" type="radio"/> cap	<input checked="" type="checkbox"/>		-
↑	<input checked="" type="checkbox"/>	<input checked="" type="checkbox"/>	<input checked="" type="checkbox"/>	<input checked="" type="checkbox"/>	<input checked="" type="checkbox"/>	<input checked="" type="checkbox"/>	<input checked="" type="checkbox"/>	<input checked="" type="checkbox"/>	<input checked="" type="checkbox"/>	<input checked="" type="checkbox"/>	<input type="checkbox"/> 100 %	<input checked="" type="checkbox"/> 0.95	<input type="radio"/> ind <input checked="" type="radio"/> cap	<input checked="" type="checkbox"/>		-
(2)	<input checked="" type="checkbox"/>	<input checked="" type="checkbox"/>	<input checked="" type="checkbox"/>	<input checked="" type="checkbox"/>	<input checked="" type="checkbox"/>	<input checked="" type="checkbox"/>	<input checked="" type="checkbox"/>	<input checked="" type="checkbox"/>	<input checked="" type="checkbox"/>	<input checked="" type="checkbox"/>	<input type="checkbox"/> 100 %	<input checked="" type="checkbox"/> 0.9	<input type="radio"/> ind <input checked="" type="radio"/> cap	<input checked="" type="checkbox"/>		-
↓	<input checked="" type="checkbox"/>	<input checked="" type="checkbox"/>	<input checked="" type="checkbox"/>	<input checked="" type="checkbox"/>	<input checked="" type="checkbox"/>	<input checked="" type="checkbox"/>	<input checked="" type="checkbox"/>	<input checked="" type="checkbox"/>	<input checked="" type="checkbox"/>	<input checked="" type="checkbox"/>	<input type="checkbox"/> 100 %	<input checked="" type="checkbox"/> 0.85	<input type="radio"/> ind <input checked="" type="radio"/> cap	<input checked="" type="checkbox"/>		-
	<input type="checkbox"/>	<input type="checkbox"/>	<input type="checkbox"/>	<input type="checkbox"/>	<input type="checkbox"/>	<input type="checkbox"/>	<input type="checkbox"/>	<input type="checkbox"/>	<input type="checkbox"/>	<input type="checkbox"/>	<input type="checkbox"/> %	<input type="checkbox"/>	<input type="radio"/> ind <input type="radio"/> cap	<input type="checkbox"/>		+

... not usable   
 ... not considered   
 ... contact open   
 ... contact closed

### UC Editor – Dynamic Power Reduction

UCs or utility companies can prescribe feed-in limits for an inverter (e.g., max. 70% of the kWp or max. 5 kW). Dynamic power reduction takes into account self-consumption in the household before the power of an inverter is reduced:

- An individual limit can be set.
- A counter for determining self-consumption per S0 can be connected directly to the inverter (for Fronius Galvo, Fronius Symo, Fronius Primo, and Fronius Eco only).



### Dynamic power reduction

(1) (2)  
Power limit:  No limit  limit for entire system  
total DC power of the system:  Wp (3)  
max. production power of entire system:   (4) (5)

Power limit  
Option to define the maximum output power of the photovoltaic system.

- (1) No limit  
The photovoltaic system converts all available PV energy and feeds it into the grid.
- (2) Dynamic power reduction limit for the entire system  
The entire photovoltaic system is limited to a fixed power limit.

- (3) Field for entering the total DC system power in Wp  
This value is used as a control reference and also in case of errors (e.g., counter failure).
- (4) Field for entering the max. power in W or %  
  
If no counter has been selected in the "Counter" menu item:  
Max. power generated for the entire system  
  
If S0 inverter has been selected in the "Counter" menu item:  
Max. energy fed into the grid
- (5) Selection field % or W
- (6) "Apply/Save" button
- (7) "Cancel/Discard entries" button

**UC Editor – Control Priorities**



**Controlling priority**

	1	2	3	
Ripple control signal receiver	<input checked="" type="radio"/>	<input type="radio"/>	<input type="radio"/>	(1)
Dynamic power reduction	<input type="radio"/>	<input checked="" type="radio"/>	<input type="radio"/>	(2)
Controlling via Modbus	<input type="radio"/>	<input type="radio"/>	<input checked="" type="radio"/>	(3)

1 = highest priority, 3 = lowest priority

- (1) Used to set control priorities for the ripple control signal receiver
- (2) Used to set control priorities for dynamic power reduction
- (3) Used to set control priorities for control via Modbus
- (4) "Apply/Save" button
- (5) "Cancel/Discard entries" button



# Appendix





# Technical Data

## Technical Data

Memory capacity	16 MB
Supply voltage	Supplied by the inverter
Energy consumption	typ. 1.4 W (without WLAN) typ. 2.2 W (with WLAN)
Dimensions	132 x 103 x 22 mm 5.2 x 4.1 x 0.9 in.
Ethernet (LAN)	RJ 45, 100 Mbit
WLAN	IEEE 802.11b/g Client
RS 485 (Fronius Solar Net)	RJ 45
Ambient temperature	-20 - +65 °C -4 - +149 °F
in conjunction with Fronius Symo 20.0-3-M	-40 - +60 °C -40 - +140 °F
Fronius Solar Net power	approx. 3 W max. 3 DATCOM components *
I/O connection specifications	
Voltage level of digital inputs	low = min. 0 V – max. 1.8 V high = min. 3 V – max. 30 V
Input currents of digital inputs	depending on the input voltage; input resistance = 46 kOhm
Switching capacity of digital outputs when supplied by the Datamanager plug-in card	3.2 W, 10.7 V in total for all 4 digital outputs (minus other Fronius Solar Net participants)
Switching capacity of digital outputs when supplied by an external power supply with min. 10.7 – max. 24 V DC	1 A, 10.7–24 V DC (depending on the external power supply) for each digital output
Max. switchable energy of digital outputs	76 mJ (per output)

\* When sufficient power is coming from Fronius Solar Net, the green LED lights up on every DATCOM component.  
If the green LED does not light up, the power pack available from Fronius should be inserted into the 12 V power pack connection socket of the DATCOM component.  
Check the cable and plug connections if necessary.





**Fronius Worldwide - [www.fronius.com/addresses](http://www.fronius.com/addresses)**

**Fronius International GmbH**  
4600 Wels, Froniusplatz 1, Austria  
E-Mail: [pv-sales@fronius.com](mailto:pv-sales@fronius.com)  
[www.fronius.com](http://www.fronius.com)

**Fronius USA LLC Solar Electronics Division**  
6797 Fronius Drive, Portage, IN 46368  
E-Mail: [pv-us@fronius.com](mailto:pv-us@fronius.com)  
[www.fronius-usa.com](http://www.fronius-usa.com)

Under [www.fronius.com/addresses](http://www.fronius.com/addresses) you will find all addresses of our sales branches and partner firms!